

Product brochure

# SediPipe® L / L plus | SediSubstrator® L

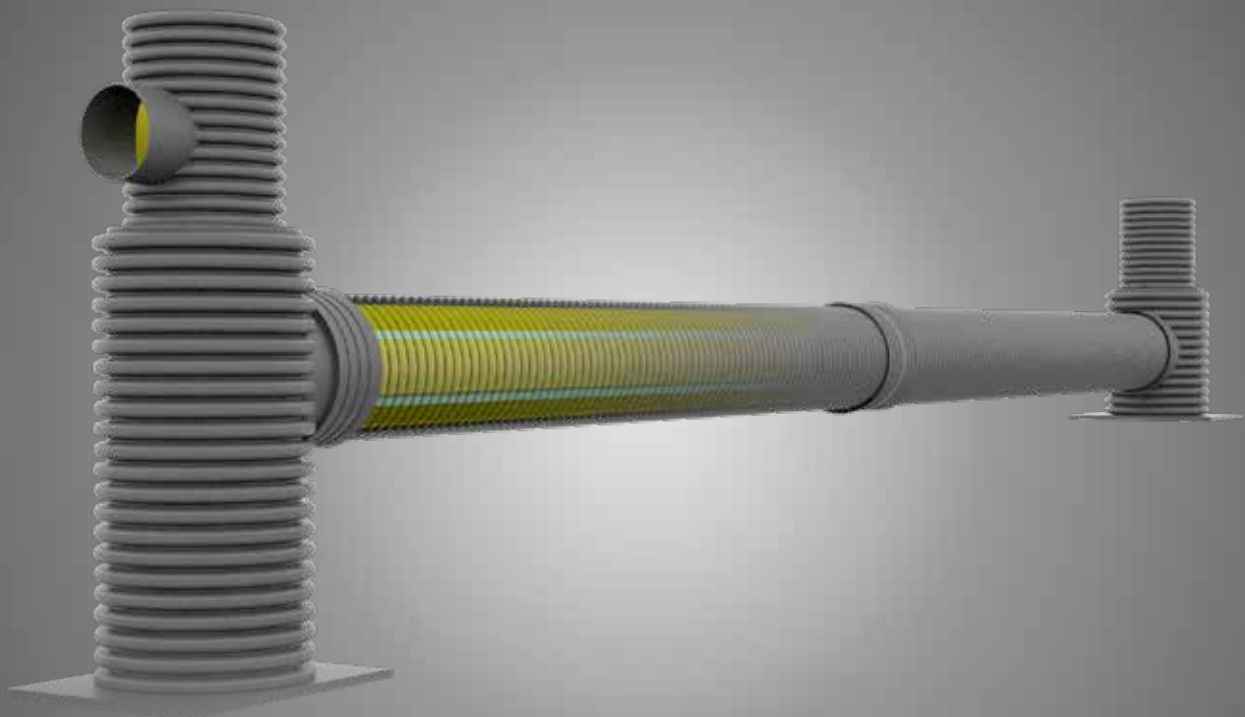

Stormwater treatment in perfection

## Basics of stormwater treatment

### Operational reliability and protection of water bodies

The stormwater collected can be polluted with different materials, such as coarse dirt, mud and light liquids from road traffic or industrial facilities. These materials can cause malfunctions of stormwater management systems, such as infiltration swales. In addition, they can pose a threat to downstream water-bodies or the groundwater.

In these cases, stormwater requires treatment prior to discharge or infiltration. This treatment shall verifiably meet the specific operational requirements, as well as regulations under the Water Act according to the state-of-the-art technology.

# Table of contents

<b>Treatment of polluted surface water</b>	<b>4</b>
<b>Design overview</b>	<b>6</b>
<b>Design dimensions overview</b>	<b>8</b>
<b>Installation examples</b>	<b>10</b>
<b>SediPipe L and SediPipe L plus – sedimentation systems</b>	<b>12</b>
Functional principle	14
Cleaning	16
Performance verifications	17
Connection geometries	21
Technical data	22
<b>SediSubstrator L – sedimentation systems with substrate step</b>	<b>24</b>
Functional principle	26
Maintenance	30
Performance verifications	32
Connection geometries	33
Technical data	34
<b>Ordering data</b>	<b>36</b>
<b>Contact</b>	<b>40</b>



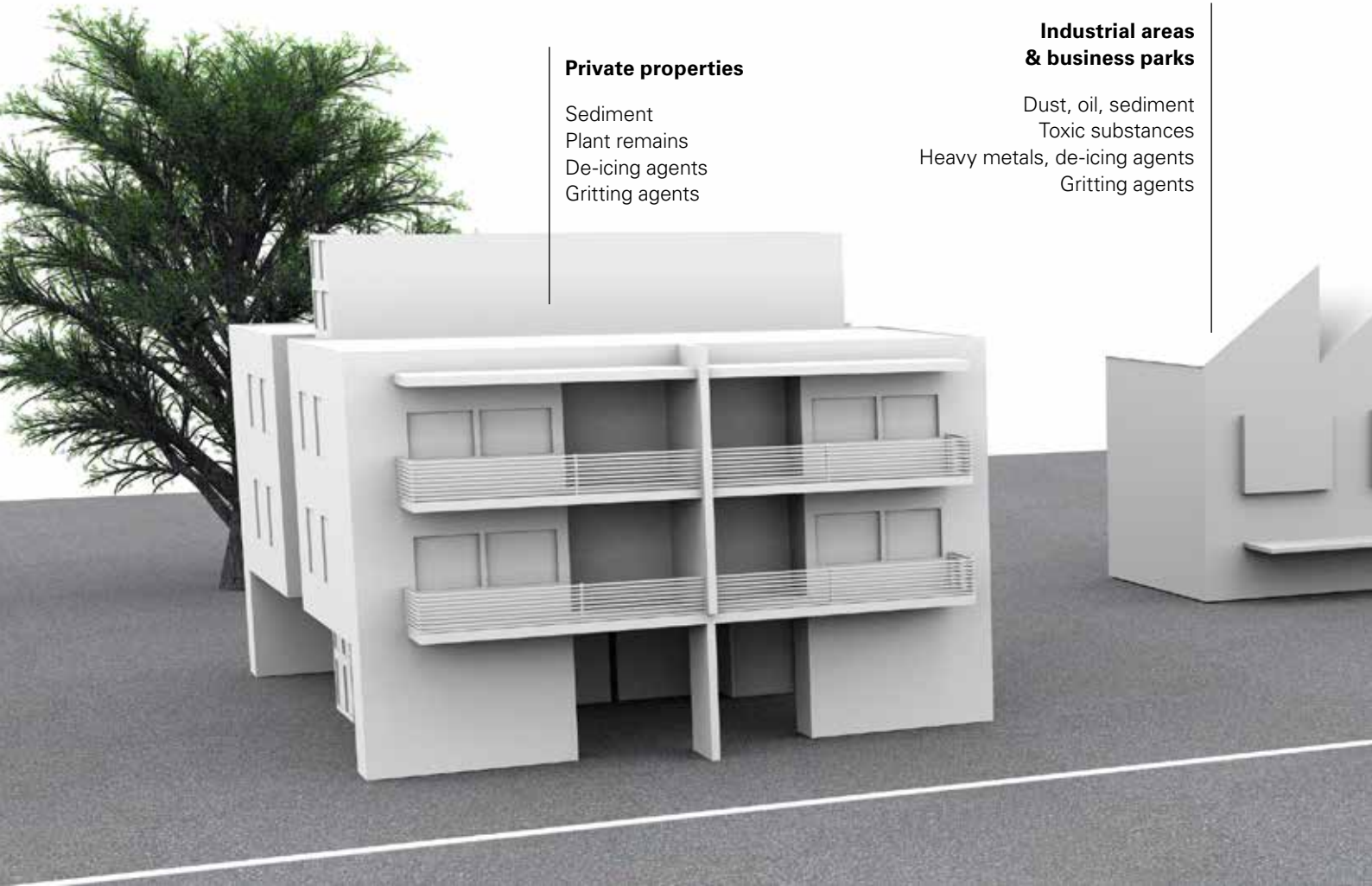

**Private properties**

Sediment  
Plant remains  
De-icing agents  
Gritting agents

**Industrial areas  
& business parks**

Dust, oil, sediment  
Toxic substances  
Heavy metals, de-icing agents  
Gritting agents

## Pollution of stormwater

Rain falls on roads, squares, roofs, stadiums and many other surfaces. Wherever stormwater cannot be treated naturally, our competencies are needed: namely protection of waterbodies and storage/infiltration systems from the discharge polluted with substances. Rocks, leaves, sand and especially fine and ultra-fine particles must be removed from stormwater to shield the storage/infiltration system from this dirt. To protect the environment, stormwater needs to be cleared of particle-bound and dissolved pollutants such as heavy metals and PAH as well as oil.



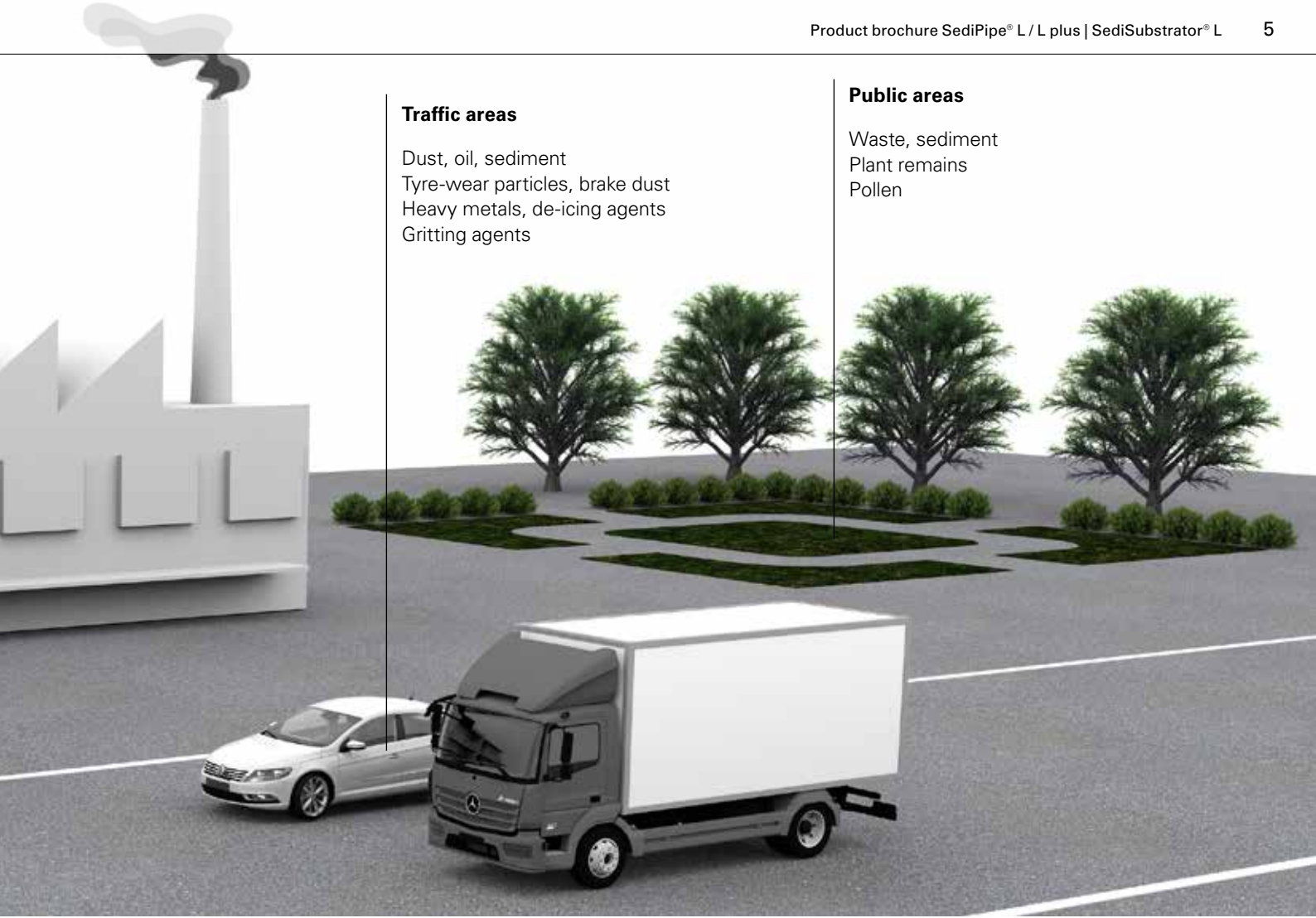

**Traffic areas**

Dust, oil, sediment  
 Tyre-wear particles, brake dust  
 Heavy metals, de-icing agents  
 Gritting agents

**Public areas**

Waste, sediment  
 Plant remains  
 Pollen

**Treatment with SediPipe® L or SediSubstrator® L**

To remove dirt and pollutants from stormwater, technical solutions such as SediPipe L and SediSubstrator L are called for, since these can fulfil this task efficiently, reliably, durably and with as little maintenance as possible.



## Design overview

### SediPipe L

#### with one flow separator

The new SediPipe L gets the traditional SediPipe operating principle down to the pat. The narrow and long design with flow separator has proven its worth over decades of permanent operation. The treatment performance has been substantiated and certified by different independent testing institutes.

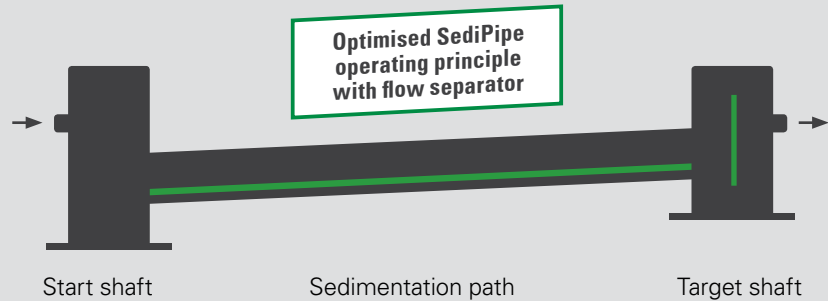

### SediPipe L plus

#### with two flow separators

SediPipe L plus convinces with the same characteristics as SediPipe L. Additionally, SediPipe L plus features a second flow separator to ensure 100 % protection for groundwater and waterbodies also in case of light liquid spills during rain.

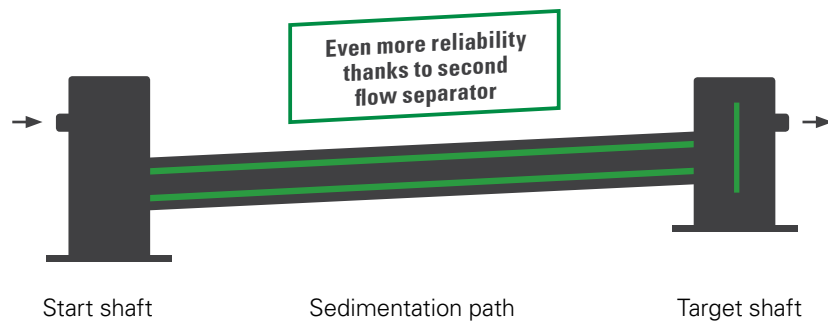

### SediSubstrator L

#### with flow separator and substrate filter unit

SediSubstrator L works like SediPipe but additionally features a downstream substrate filter unit which additionally filters dissolved heavy metals from surface water. SediSubstrator L is the system of choice for areas with a high volume of heavy goods vehicle traffic.



# Design overview

## SediPipe L

### Pollution



heavy

### Retention of ...

- coarse particles
- fine particles
- bound pollutants
- light liquids

### Traffic load



### Applications

Residential and commercial areas with moderate heavy goods vehicle traffic



Protection from spills in dry weather

## SediPipe L plus

### Pollution



very heavy

### Retention of ...

- coarse particles
- fine particles
- bound pollutants
- light liquids

### Traffic load



### Applications

Residential and commercial areas with increased heavy goods vehicle traffic



Protection from spills in dry weather and during rain

## SediSubstrator L

### Pollution



extreme

### Retention of ...

- coarse particles
- fine particles
- bound pollutants
- light liquids
- dissolved pollutants

### Traffic load



### Applications

Commercial areas, logistics centres and motorway lay-bys highly frequented by heavy goods vehicle traffic



Protection from spills in dry weather and during rain

## Design dimensions overview

### SediPipe L

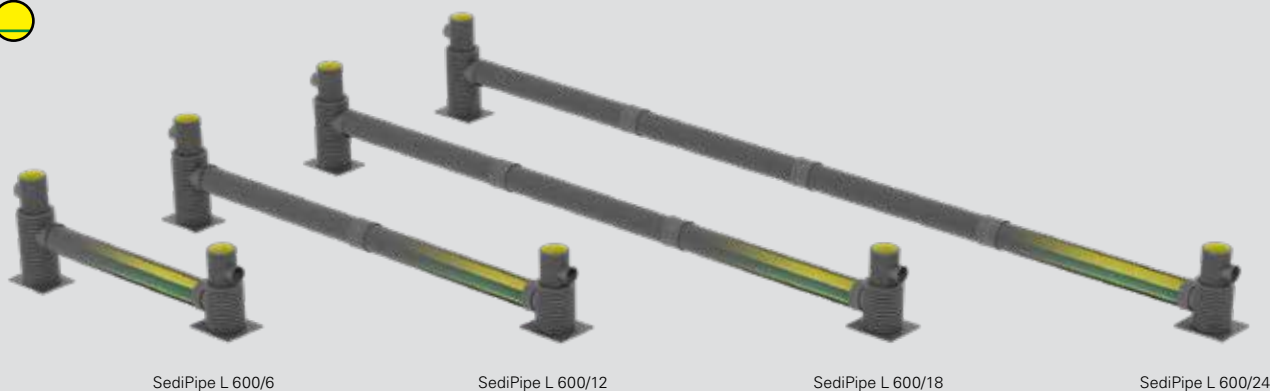

SediPipe L 600/6

SediPipe L 600/12

SediPipe L 600/18

SediPipe L 600/24

### SediPipe L plus

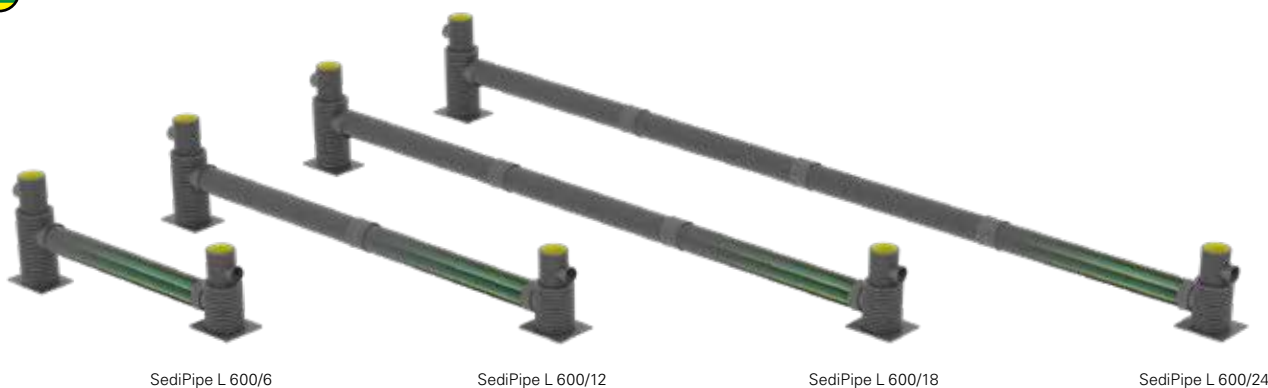

SediPipe L 600/6

SediPipe L 600/12

SediPipe L 600/18

SediPipe L 600/24



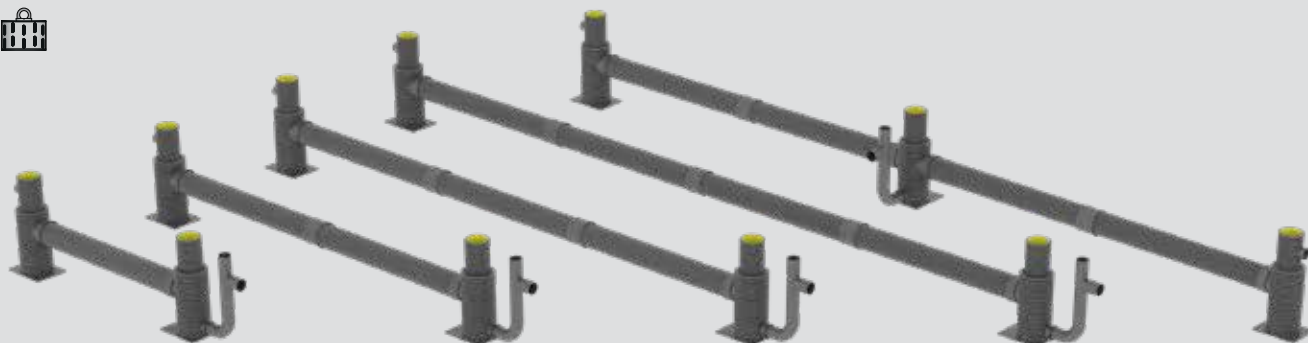

### SediSubstrator L

SediSubstrator L  
600/6SediSubstrator L  
600/12SediSubstrator L  
600/18SediSubstrator L  
600/24SediSubstrator L  
600/12+12







# Design dimensions overview











## SediPipe L

System types	Pipe Ø	Length of sedimentation path
SediPipe L 600/6	DN 600	
SediPipe L 600/12	DN 600	
SediPipe L 600/18	DN 600	
SediPipe L 600/24	DN 600	

## SediPipe L plus

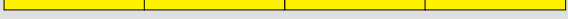
System types	Pipe Ø	Length of sedimentation path
SediPipe L plus 600/6	DN 600	
SediPipe L plus 600/12	DN 600	
SediPipe L plus 600/18	DN 600	
SediPipe L plus 600/24	DN 600	

## SediSubstrator L

System types	Pipe Ø	Length of sedimentation path	Cartridge elements
SediSubstrator L 600/6	DN 600		
SediSubstrator L 600/12	DN 600		
SediSubstrator L 600/18	DN 600		
SediSubstrator L 600/24	DN 600		
SediSubstrator L 600/12+12	DN 600		

## Installation examples upstream of storage/infiltration system

### Minimised construction field (next to storage/infiltration system)

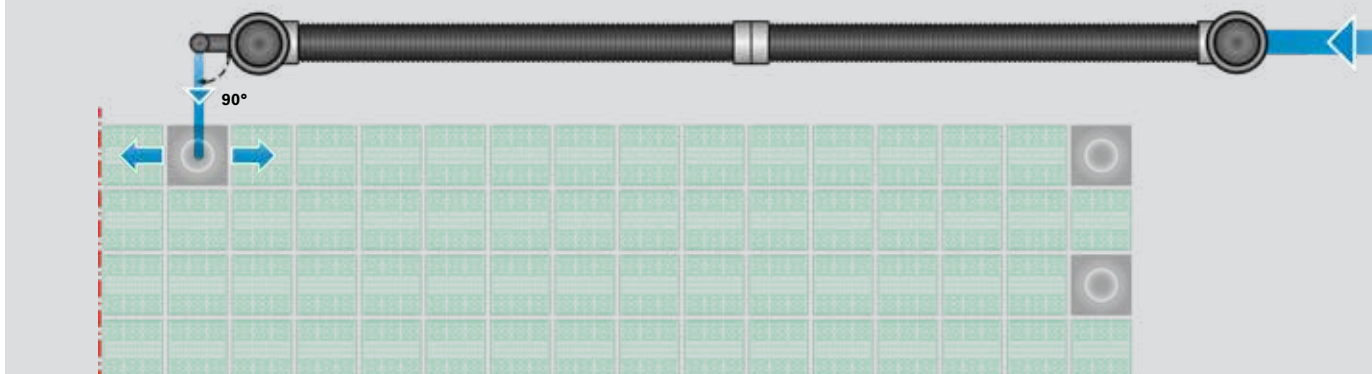

### Very large collection areas (2-fold parallel arrangement)

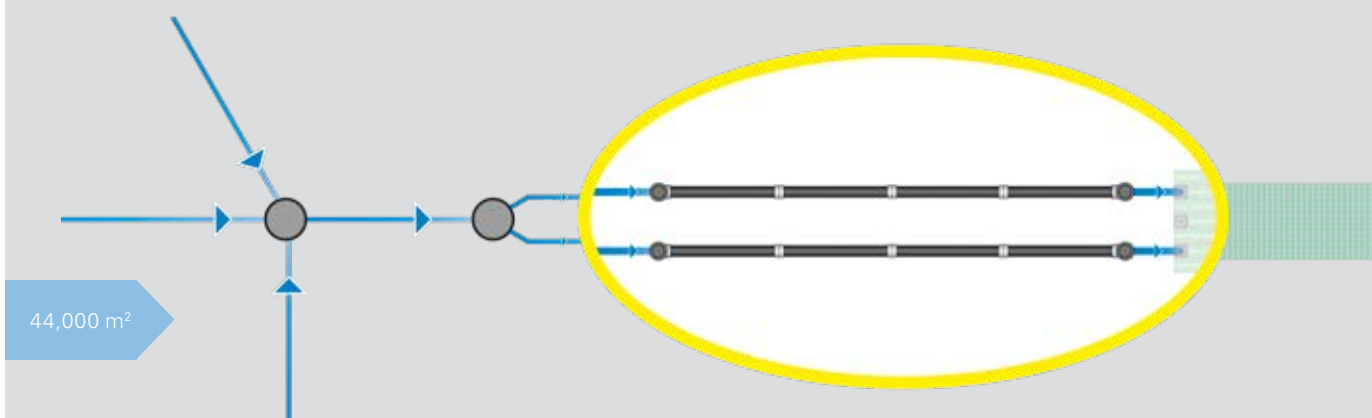

### Very large collection areas (4-fold parallel arrangement)

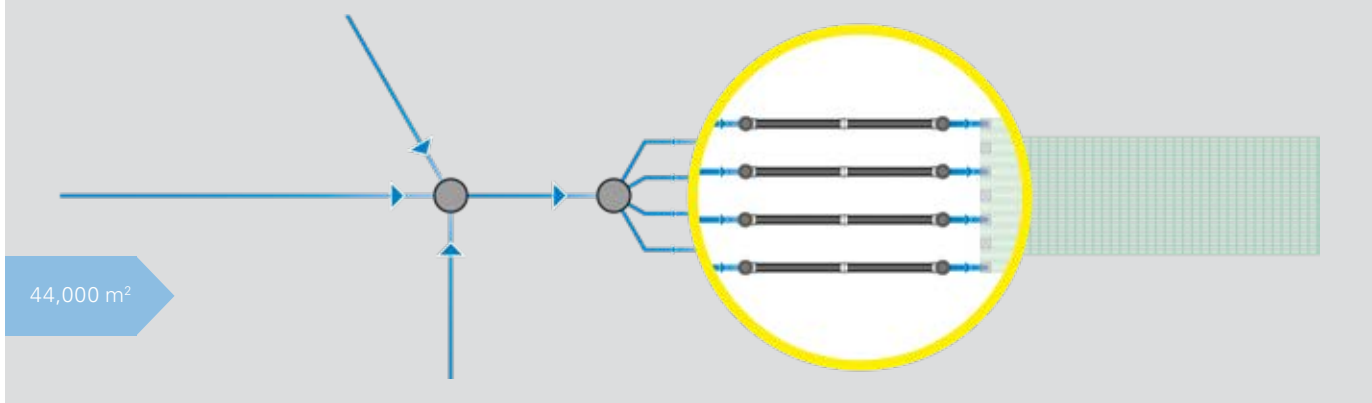

# Installation examples upstream of waterbodies

## Freely selectable angles

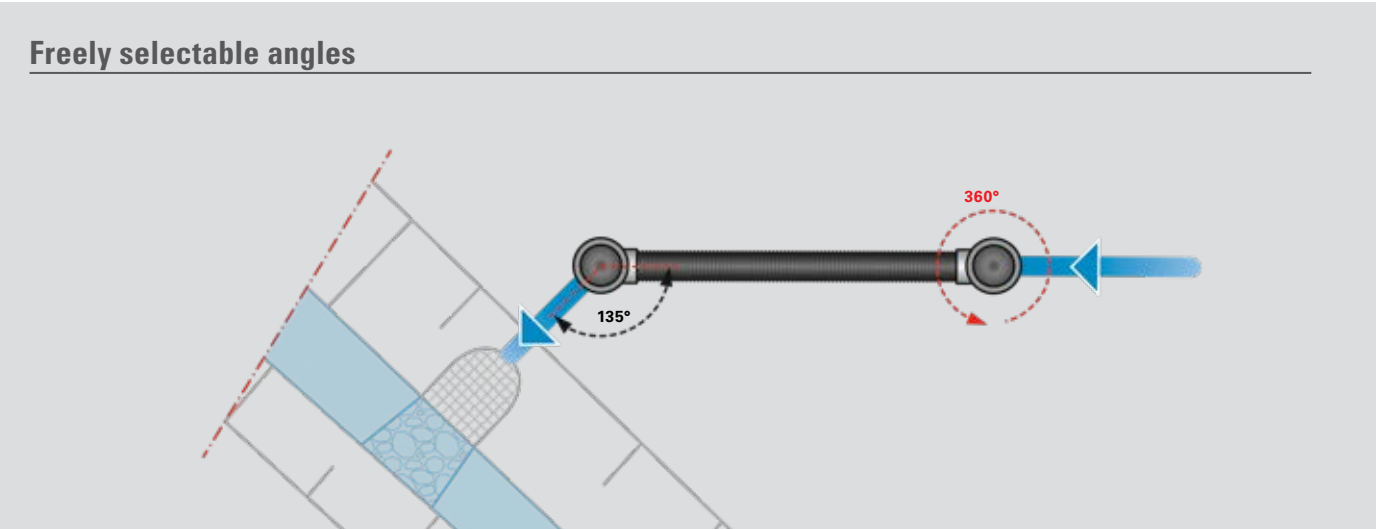

## Space-saving (along roads)

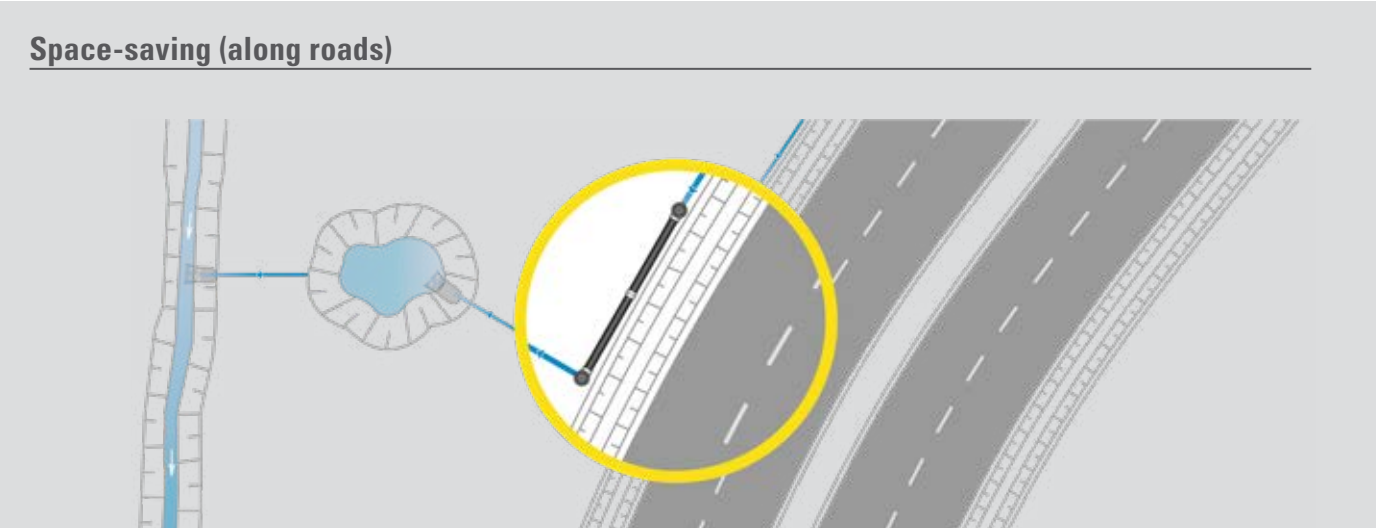

## Installation under existing media

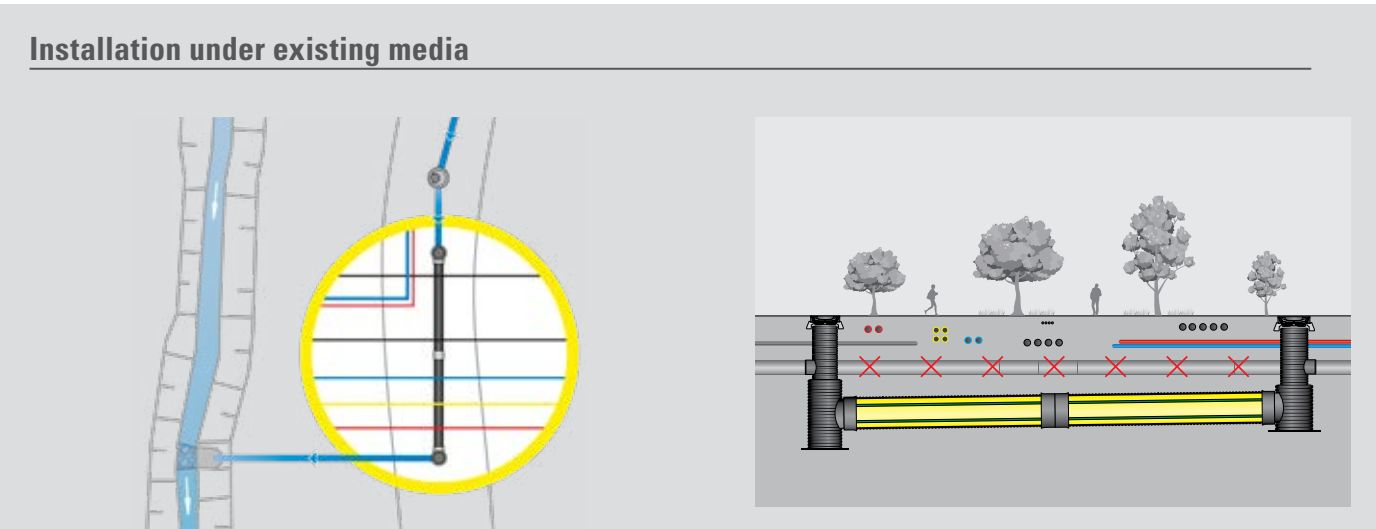

## SediPipe® L and SediPipe® L plus

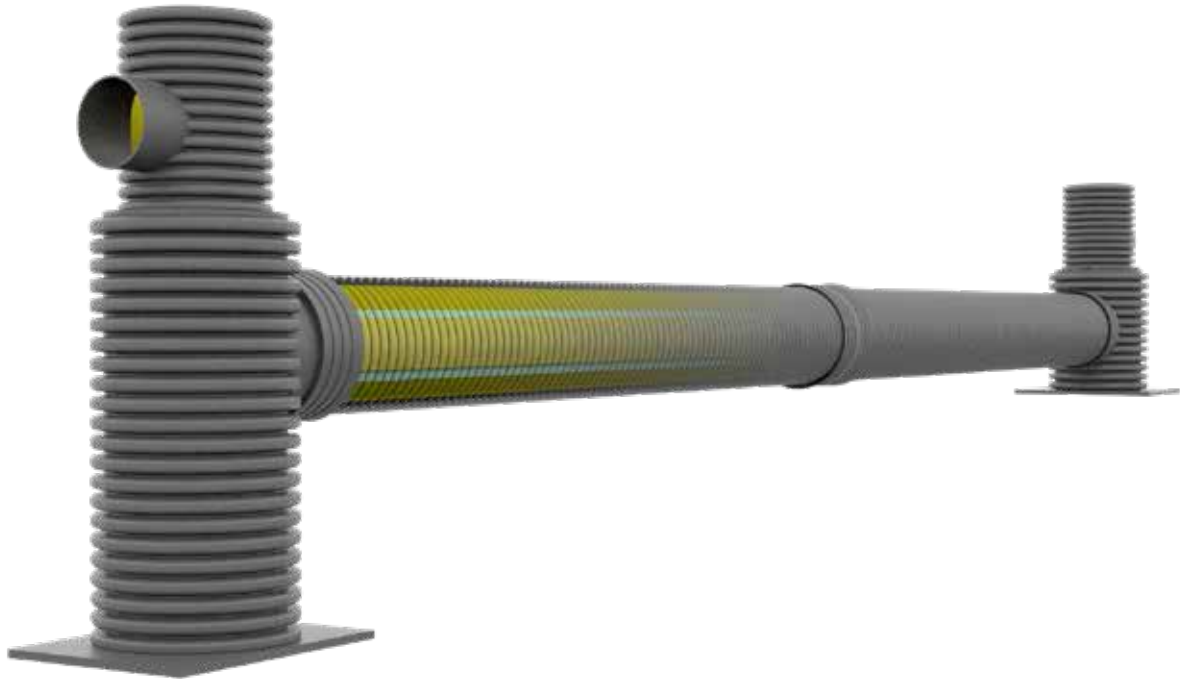
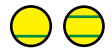

### SediPipe L and SediPipe L plus

---

#### **Optimised treatment performance with patented flow separator**

The stretched and compact sedimentation chamber ensures short times and distances until sediment settles and guarantees an optimised treatment performance. Sediment already settled cannot be remobilised even in case of heavy rains. The long and narrow design integrates optimally in the channel route, regardless of whether along stretched structures such as roads, at the inlet to storage/infiltration systems or in case of modernisation of a discharge point into surface waterbodies under the German Water Act.

## Advantages

- + Proven treatment performance and sediment control
- + Optimised sedimentation process and retention of fine particles thanks to flow harmonisation
- + Greatest flexibility because, depth and connection angle can be adjusted on site
- + For small to very large collection areas
- + Quick and easy installation thanks to pre-fabricated systems with low weights
- + No space on the surface required (completely underground installation)
- + Space-saving arrangement, minimised construction field (on the channel route, under existing media)
- + Easy cleaning using common sewer cleaning technology
- + Retrofitting of existing systems

# Functional principle of SediPipe® L and SediPipe® L plus –

## Start shaft

as mud collector

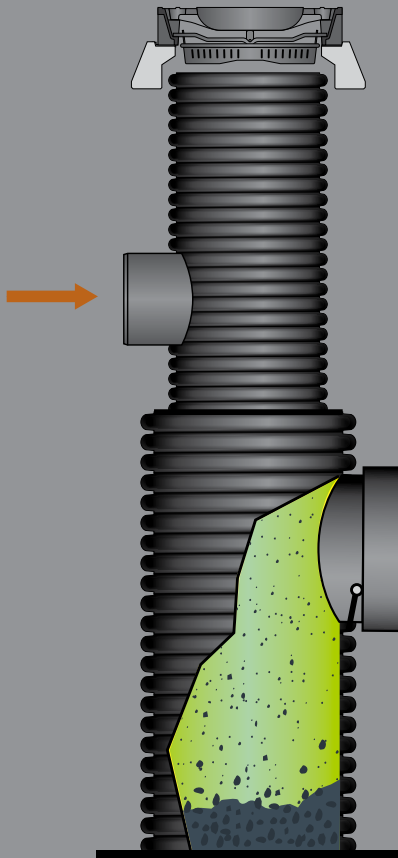

## Retention of coarse particles



Coarse dirt particles settle already in the start shaft. The start shaft acts as a mud collector.

## Sedimentation path

with flow separator

**Treatment performance proven by the following independent institutes**

TUV Rheinland LGA	TAUW & TU Delft	IKT	IFS Hannover	HTWK IWS
-------------------------	--------------------	-----	-----------------	-------------

Upper flow separator  
for SediPipe L plus systems only

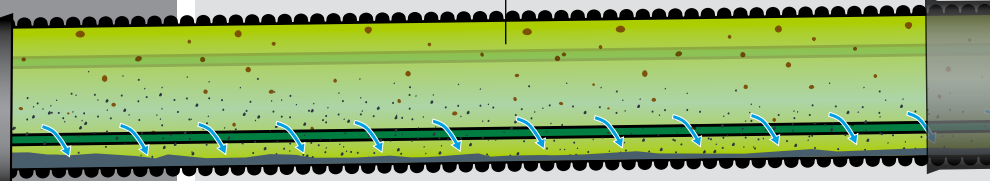

## Flow separator (bottom)

## Optimised sedimentation process of fine particles



The stretched and narrow sedimentation chamber reduces the time and distance until particles settle, and causes flow harmonisation. Both factors together prevent turbulences and thus ensure an optimal sedimentation process.

## Sediment control

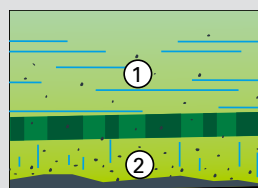

① harmonised plug flow  
② controlled sediment

The patented flow separator technology creates an area with little water movement in the depot, thus preventing remobilisation of the sediment already settled even in case of heavy rains.

# with flow separator technology

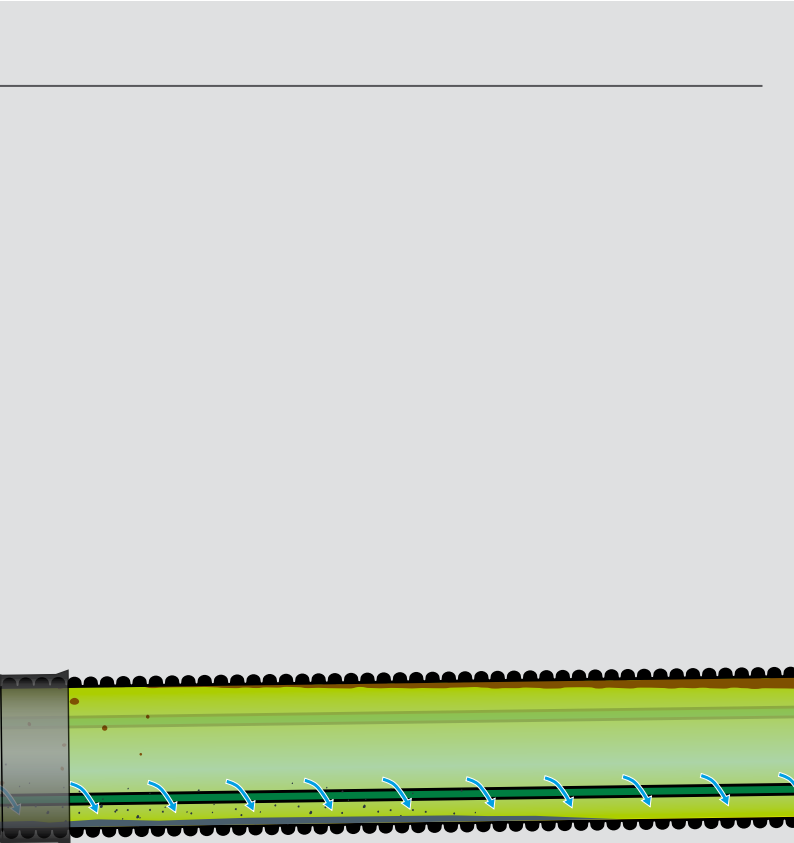

## Target shaft

with immersion wall

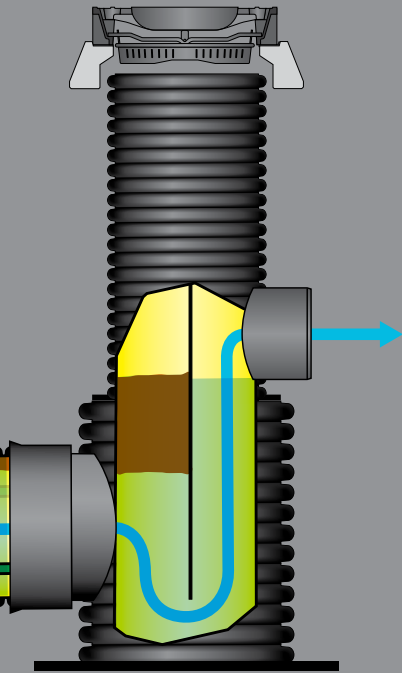

### Flow separator (top)

#### Additional function with L plus systems



- Separation of light liquids in case of spills during rain or fire (fire water)
- Separation performance of a coalescence separator

#### High-performance oil retention

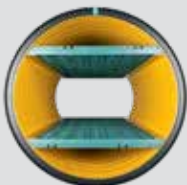

- Extra safety
- Efficient spill precaution
- Easy cleaning and quick return to service

SediPipe L plus

### Retention of light liquids

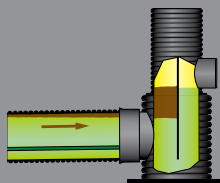

Due to the slight gradient of the pipe, light liquids that rise upwards in the sedimentation path enter the target shaft in which they are collected.

### Immersion wall for sediment control

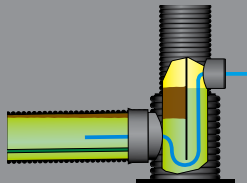

The immersion wall integrated into the target shaft controls the sediment.



## Cleaning

Common sewer cleaning methods are used to clean the system. All work is performed without requiring access from above ground. The system keeps a permanent water level which ensures that the sediment remains muddy. The contents of the system are vacuumed from the start

shaft. The valve flap opens and releases the sediment to the lowest point. The target shaft is now vacuumed and cleaned. Afterwards, the system is flushed, refilled and can be operated again.

**Note**

**Please refer to the installation and maintenance manual for a detailed description.**



[www.fraenkische.com](http://www.fraenkische.com)

### Step 1: Emptying with vacuum hose

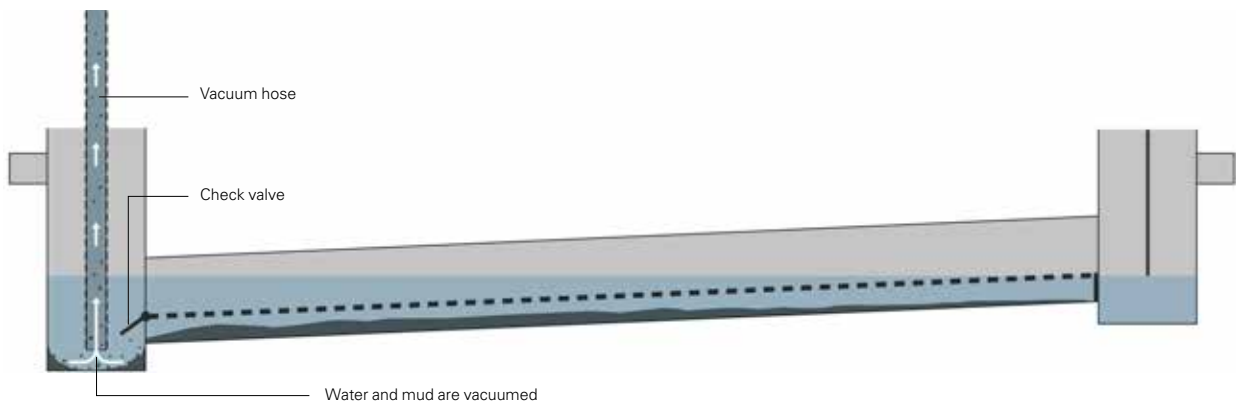

### Step 2: Cleaning with vacuum and flush hose

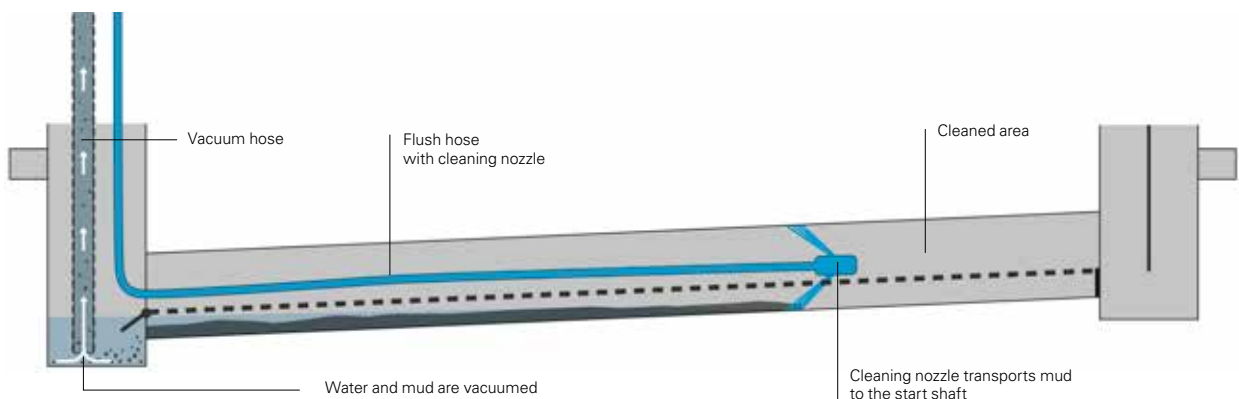



# Performance parameters – SediPipe® L / SediPipe® L plus

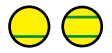

## Use of SediPipe® according to DWA-M 153 table A.4c type D25

**Type D25 sedimentation systems according to DWA-M 153 are sedimentation systems that have been designed with a maximum flow rate of 18 m/h.**

Sedimentation systems are used to sediment solids with a grain diameter greater than approx. 0.1 mm.

# D 25

Pass-through value acc. to  
DWA bulletin M 153

## 0.80 to 0.35

System type	D25			
Pass-through value	0.80	0.70	0.65	0.35
$r_{crit}$ [l/(s·ha)]	15	30	45	$r_{(15.1)}$ <sup>2)</sup>

SediPipe L/L plus	Connectable area $A_u$ (m <sup>2</sup> )			
600/6	11,900 <sup>1)</sup>	5,950	3,950	1,800
600/12	23,350 <sup>1)</sup>	11,700 <sup>1)</sup>	7,800 <sup>1)</sup>	3,500
600/18	30,350 <sup>1)</sup>	15,150 <sup>1)</sup>	10,100 <sup>1)</sup>	4,550
600/24	44,450 <sup>1)</sup>	22,200 <sup>1)</sup>	14,800 <sup>1)</sup>	6,650

<sup>1)</sup> As of 7,500 m<sup>2</sup>  $A_u$  (for  $r_{dim} = 200$  l/(s·ha)) project-specific hydraulic considerations are required.  
Values rounded to whole 50 m<sup>2</sup>.

<sup>2)</sup> at  $r(15.1) = 100$  l/(s·ha)

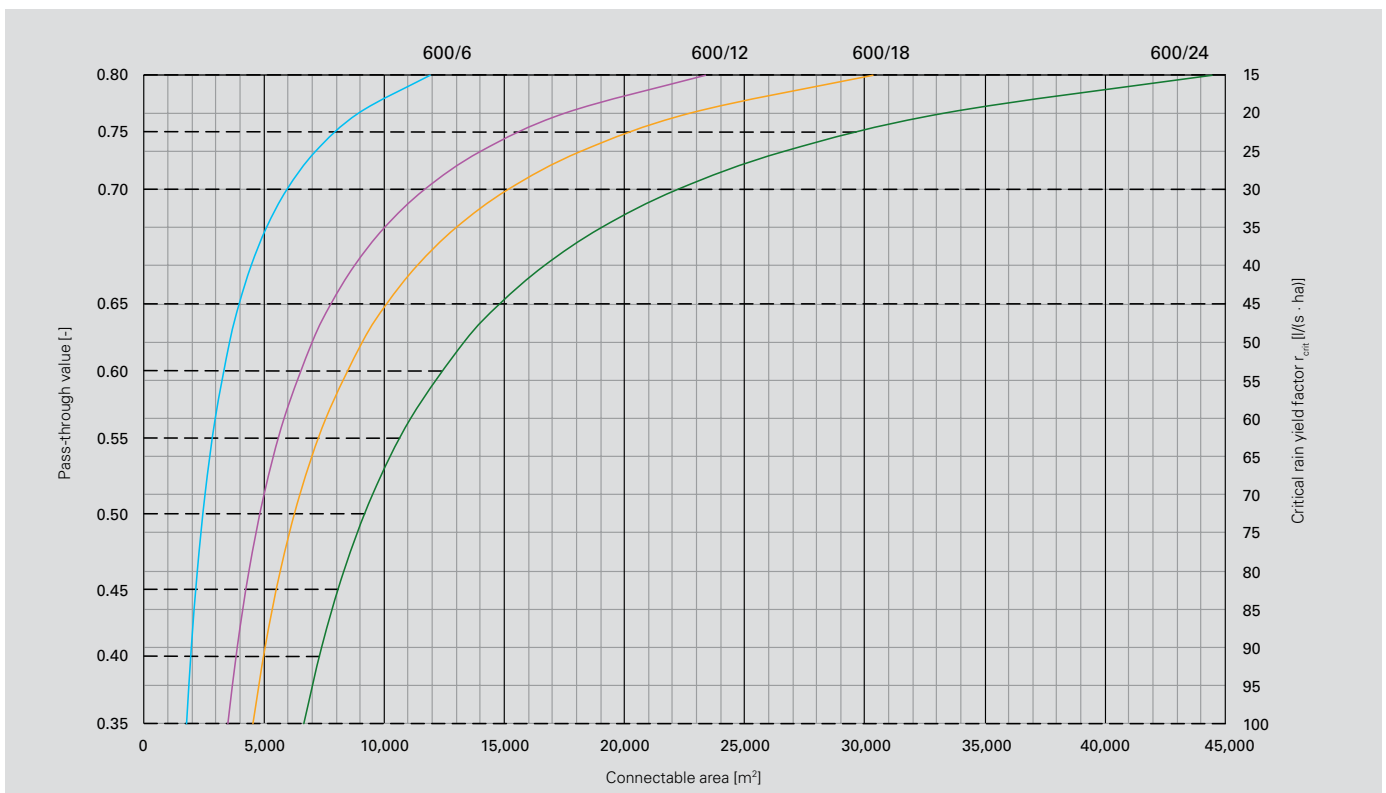

SediPipe performance characteristics, connectable area  $A_u$ , depending on the required pass-through value acc. to DWA-M 153, D25

# Performance parameters – SediPipe® L / SediPipe® L plus

## Use of SediPipe® according to DWA-M 153 table A.4c type D24

Type D24 sedimentation systems according to DWA-M 153 are stormwater sedimentation tanks that have been designed with a maximum flow rate of 10 m/h. These systems have been designed for the separation of finest

grain fractions. In addition, the precipitated sediment must not be swirled up, even with high hydraulic loads. SediPipe meets these requirements.

**D 24**

Pass-through value acc. to  
DWA bulletin M 153

**0.65 to 0.25**

System type	D24			
Pass-through value	0.65	0.55	0.50	0.25
$r_{crit}$ [l/(s · ha)]	15	30	45	$r_{(15,1)}$ <sup>2)</sup>

**Note**

Country-specific dimensions, e.g., those of Baden Württemberg (see working aids for handling stormwater in settlement areas [*Arbeitshilfen für den Umgang mit Regenwasser in Siedlungsgebieten*], table 4b) can be calculated, if necessary.

SediPipe L/L plus	Connectable area $A_u$ (m <sup>2</sup> )			
600/6	6,550	3,250	2,200	1,000
600/12	13,250 <sup>1)</sup>	6,650	4,400	2,000
600/18	16,450 <sup>1)</sup>	8,250 <sup>1)</sup>	5,500	2,450
600/24	25,100 <sup>1)</sup>	12,550 <sup>1)</sup>	8,350 <sup>1)</sup>	3,750

<sup>1)</sup> As of 7,500 m<sup>2</sup>  $A_u$  (for  $r_{dim} = 200$  l/(s · ha)) project-specific hydraulic considerations are required. Values rounded to whole 50 m<sup>2</sup>.

<sup>2)</sup> at  $r_{(15,1)} = 100$  l/(s · ha)

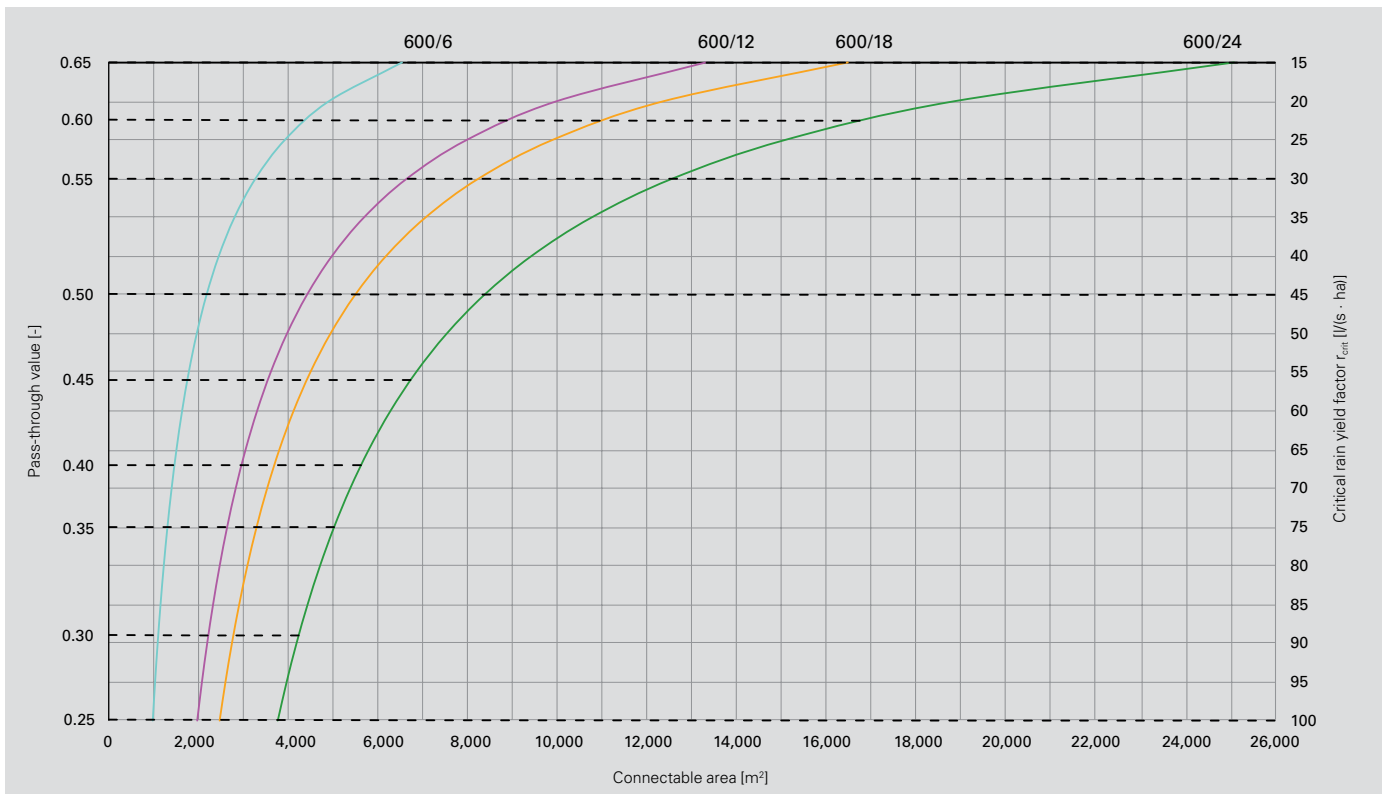

SediPipe performance characteristics, connectable area  $A_u$ , depending on the required pass-through value acc. to DWA-M 153, D24

# Performance parameters – SediPipe® L / SediPipe® L plus

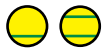

## Use of SediPipe® according to DWA-M 153 table A.4c type D21

### Note

**Type D21 sedimentation systems according to DWA-M 153 are systems with a maximum flow rate of 9 m/h at the load case for rain with the rain yield factor  $r_{(15.1)}$ <sup>1)</sup>.**

These systems have been designed for the separation of finest grain fractions. In addition, the precipitated sediment must not be swirled up, even with high hydraulic loads. SediPoint meets these requirements.

<b>D 21</b>
Pass-through value acc. to DWA bulletin M 153
<b>0.20</b>

System type	D21																
Pass-through value	0.2																
$r_{(15.1)}$ <sup>1)</sup> [l/(s · ha)]	90	95	100	105	110	115	120	125	130	135	140	145	150	155	160	165	170

SediPipe L/L plus	Connectable area $A_u$ (m <sup>2</sup> )																
600/6	991	938	891	849	810	775	743	713	686	660	637	615	594	575	557	540	524
600/12	1,960	1,857	1,764	1,680	1,604	1,534	1,470	1,411	1,357	1,307	1,260	1,217	1,176	1,138	1,103	1,069	1,038
600/18	2,529	2,396	2,276	2,167	2,069	1,979	1,896	1,821	1,751	1,686	1,626	1,570	1,517	1,468	1,422	1,379	1,339
600/24	3,717	3,522	3,346	3,186	3,042	2,909	2,788	2,677	2,574	2,478	2,390	2,307	2,230	2,159	2,091	2,028	1,968

<sup>1)</sup>  $r_{(15.1)}$  = rain yield factor with a rainfall duration of 15 min. and annual recurrence

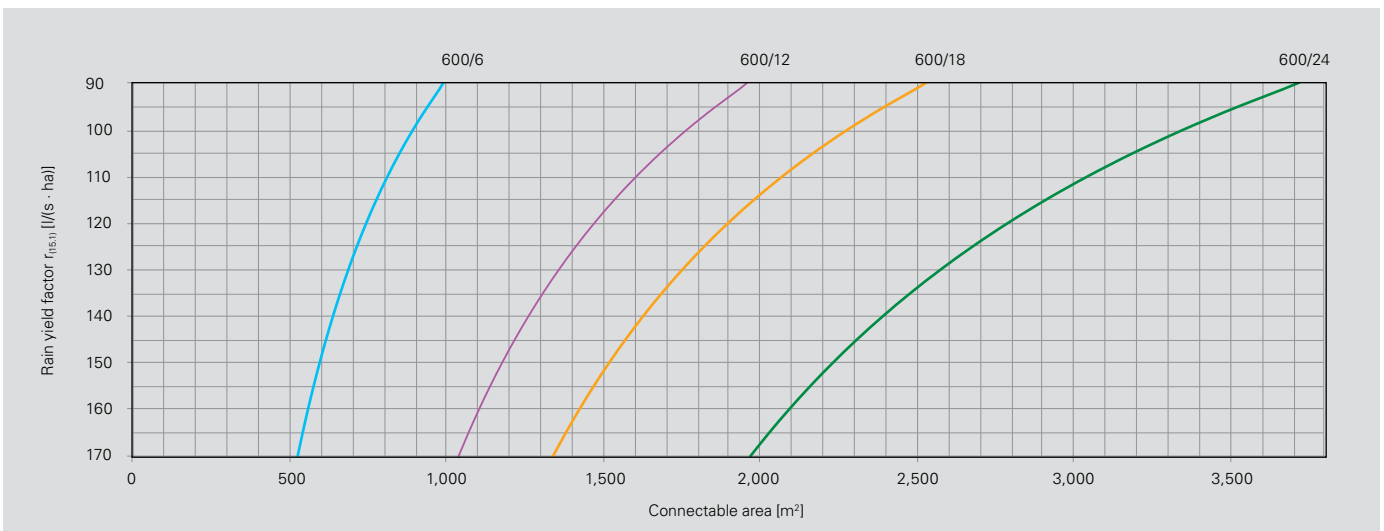

SediPipe performance characteristics, connectable area  $A_u$ , depending on the required pass-through value acc. to DWA-M 153, D21

# Performance parameters – SediPipe® L plus

## Application of SediPipe® L plus

Should spills occur, type D25, D24 and D21 SediPipe systems reliably retain large amounts of light liquids in dry weather and separate particles in general.

SediPipe L plus types even achieve the same separation performance as coalescence separators during rain. SediPipe L plus can protect vulnerable areas, such as those under the RiStWag directive for construction works on roads in capture areas (water protection zones), against light liquids.

### Proven separation performance

SediPipe L plus systems have been tested for the retention of light liquids by TÜV Rheinland LGA Products GmbH.

The discharge values match those of a class I oil separator according to DIN EN 858-1 (residual oil level  $\leq 5.0$  mg/l, which corresponds to an oil retention of at least 99.9 %).

Oil separation performance certified by

TÜV  
Rheinland  
LGA



### Note

**SediPipe L plus is no oil separator**

### Tested flow rate of SediPipe L plus

Test	Acc. to DIN EN 858, separator class I	Acc. to DIN EN 858, separator class II	Discharge in case of heavy rain
<b>Discharge concentration</b>	<b>max. 5 mg/l</b>	<b>max. 100 mg/l</b>	<b>max. 5 mg/l</b>
<b>Performance parameter</b>	Corresponds to the separation performance of a coalescence separator	Corresponds to the separation performance of a gravity separator	The sediment is controlled
SediPipe L plus 600/6	20 l/s	30 l/s	100 l/s
SediPipe L plus 600/12	30 l/s	40 l/s	100 l/s
SediPipe L plus 600/18	30 l/s	40 l/s	100 l/s
SediPipe L plus 600/24	30 l/s	40 l/s	100 l/s

# Connection geometries – SediPipe® L / SediPipe® L plus



## Connection angles

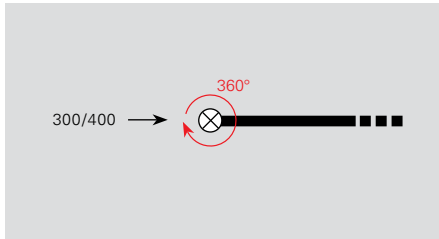

Plan start shaft inlet  
(DN300 or DN400)

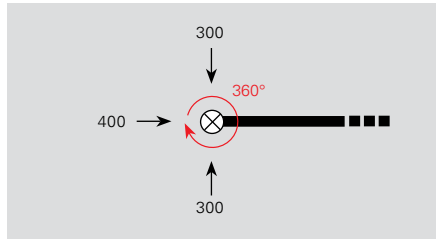

Plan start shaft 3 inlets  
(1x DN400, 2x DN300, 90° angle)

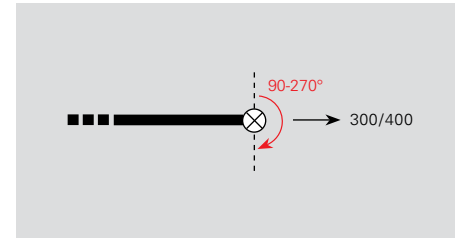

Plan target shaft outlet  
(DN300 or DN400)

## Arrangement of multiple systems

The following describes the recommendations for the arrangement of multiple systems and the required minimum distances. We draw your attention to the fact that for installation clearances

between distribution and combining units and the treatment system, the respective fitting dimensions of the connection pipes and their space requirements must be considered for

the installation in addition to the general minimum clearances specified by standards.

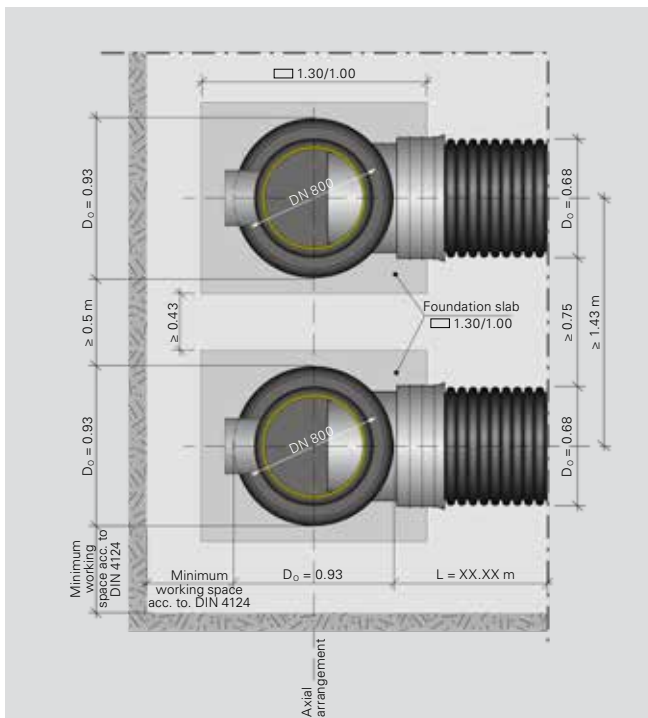

Axial arrangement

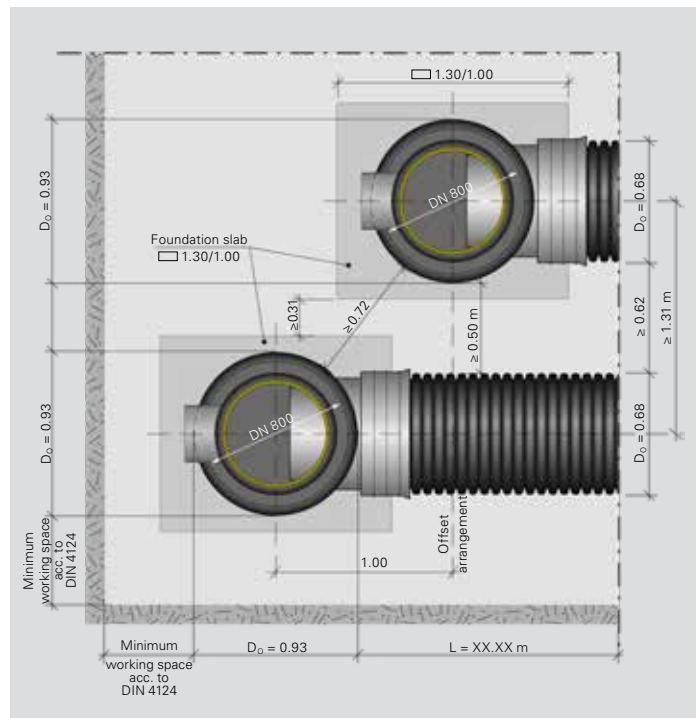

Offset arrangement

We recommend a minimum clearance of 1.43 m or more referring to the shaft centres for axial arrangements. We recommend a minimum spacing between the axes of 1.31 m for offset arrangements of shaft constructions.

Additionally pay attention to the offset arrangement of shaft constructions of 1.0 m or more. If the recommended clearances for the respective installation situations are complied with, there is a breadth of working space of at least

0.5 m between the two shaft constructions or between the shaft construction and the sedimentation path. This is to ensure professional compaction between the system components using light compacting equipment.

# Technical data – SediPipe® L / SediPipe® L plus

In case of SediPipe L systems, inlet and outlet are same level. This allows minimum installation depths of the drainage pipe and/or the downstream systems.

SediPipe L can be used universally for a wide range of purposes:

- Discharge into a surface waterbody or sewer
- Installation upstream of or parallel to a storage/infiltration system

The inlet at the start shaft is 360 degrees rotatable. Inlet and outlet diameters can be selected in DN 300 or DN 400. The flow direction of the target shaft can be adjusted to a desired angle between 90° and 270° on site. The system can therefore be easily adapted to on-site requirements.

The stability of the system has been proven by standard statics. For soil temperatures up to 23 °C, maximum installation depths of the shafts up to 6 m, also in case of groundwater, are possible depending on installation parameters.

The minimum depth of the system derives from the minimum required distance between the pipe crown, inlet and/or outlet channel and the bottom edge of the BARD ring of 35 cm. With a conventional class D cover without equalisation ring this corresponds to an inlet channel soil depth of 1.02 m for a DN/OD 315 connection. Connections DN/OD 400 correspond to an inlet channel soil depth of 1.10 m.

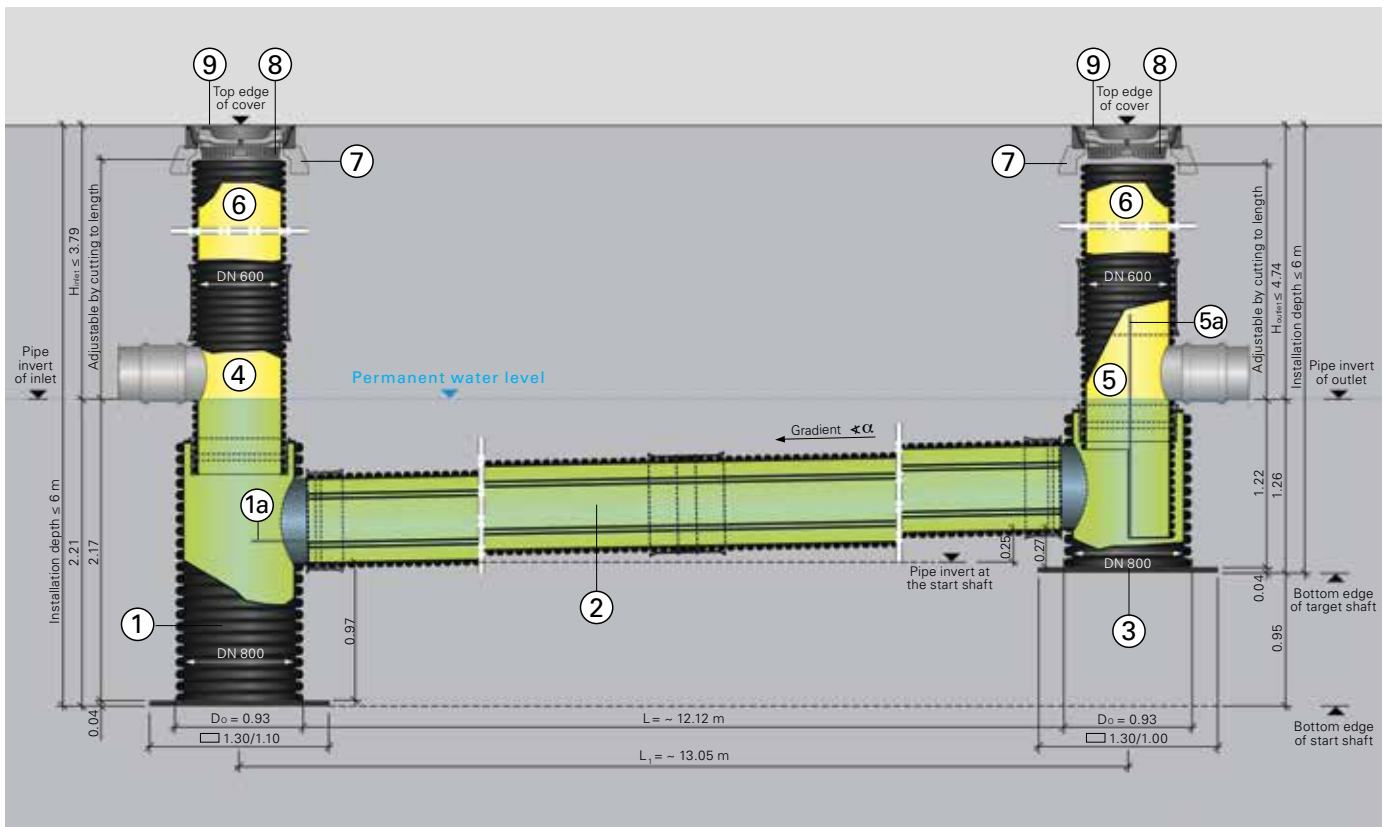

Section SediPipe L 600/12

- |   |  |
|---|--|
| <ul style="list-style-type: none"> <li>① Start shaft bottom with</li> <li>①a maintenance console</li> <li>② Sedimentation path with flow separator (and upper flow separator with L plus)</li> <li>③ Target shaft bottom</li> <li>④ Inlet set DN 600</li> </ul> | <ul style="list-style-type: none"> <li>⑤ Outlet set DN 600 with immersion wall</li> <li>⑤a</li> <li>⑥ Extension pipe DN/ID 600</li> <li>⑦ BARD ring (class D concrete support ring)</li> <li>⑧ Dirt trap acc. to DIN 1221<sup>1)</sup></li> <li>⑨ Shaft cover CW 610<sup>1)</sup></li> </ul> |
|---|--|

<sup>1)</sup> to be ordered / supplied on site

## Technical data – SediPipe® L / SediPipe® L plus



SediPipe L	600/6	600/12	600/18	600/24
Length "L" [m]	6.10	12.12	18.17	24.22
Length "L <sub>1</sub> " [m]	7.03	13.05	19.10	25.15
Diameter of the sedimentation path [mm]	600	600	600	600
Sedimentation path gradient [%]	4.0	2.0	1.3	1.0
Sedimentation path gradient as angle [α]	2.3°	1.1°	0.8°	0.6°
Collecting volume of light liquids [litres] <sup>1)</sup>	1990	3270	4560	5860
Collecting volume of the mud chamber [litres]	770	970	1180	1390

<sup>1)</sup> Retention of light liquids in case of spills in dry weather

### Shaft cover CW 610 (on site) and BARD ring

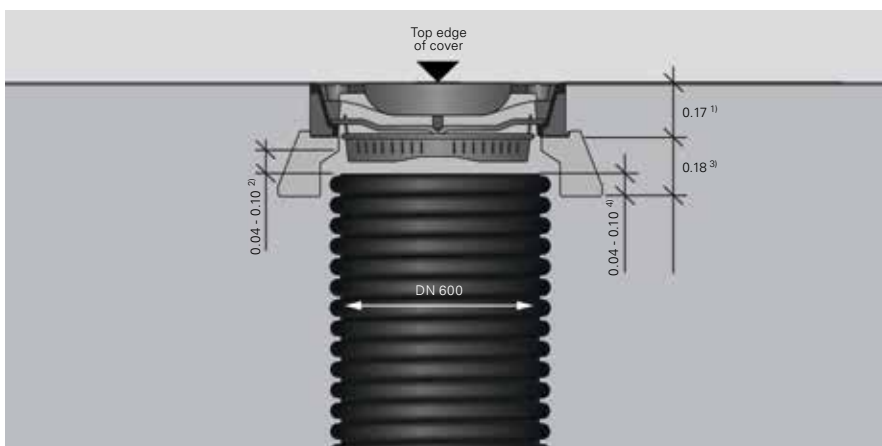

- <sup>1)</sup> Height of shaft cover incl. 1 cm mortar joint. The dimension is variable, depending on class B or D shaft cover and use of additional support rings (incl. mortar joint to ensure a bearing without stationary loads).
- <sup>2)</sup> Compensating area: 4 cm to 10 cm
- <sup>3)</sup> BARD ring, inside Ø 745 mm, h = 180 mm
- <sup>4)</sup> Insertion area: Extension pipe in BARD ring 4 cm to 10 cm, height adjustment in the insertion area accurate to within the last centimetre possible.

# SediSubstrator® L

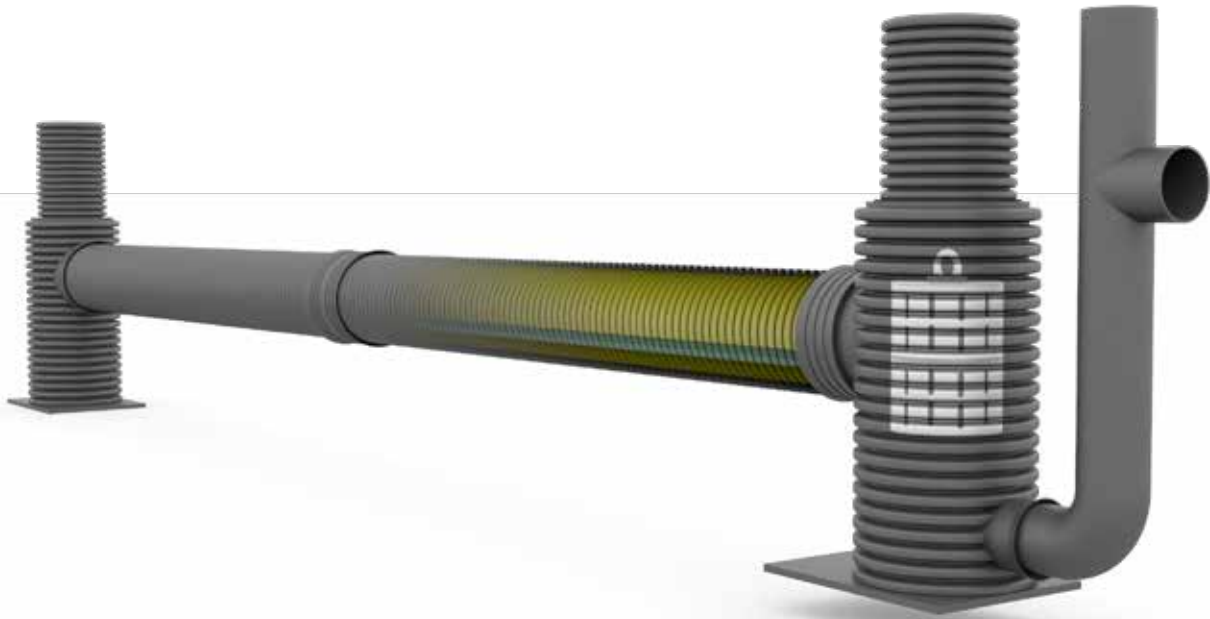

## SediSubstrator® L

### Highest reliability thanks to the 2-stage principle

The combination of adsorption by means of a substrate and upstream sedimentation using the proven flow separator technology leads to optimum treatment performance. Since virtually the entire necessary retention of all solids and fine particles takes place in the sedimentation path, the particular task of the downstream substrate filter is to bind dissolved pollutants. This thus excludes the risk of blockages and guarantees a long service life of the substrate filter cartridge.

SediSubstrator L has been tested according to the strict DIBt requirements and therefore facilitates official approval procedures regarding stormwater infiltration systems and, depending on the country, also discharge into surface waterbodies.





## Advantages

- + Greatest flexibility, because depth and connection angle can be adjusted on site
- + DIBt approval: facilitates approval of the system under the German Water Act
- + Operationally reliable 2-step principle – no risks of blockages of the substrate cartridge
- + For small to very large collection areas
- + Quick and easy installation thanks to pre-fabricated systems with low weights
- + No space on the surface required (completely underground installation)
- + Space-saving arrangement, minimised construction field (on the channel route, under existing media)
- + Easy maintenance with conventional sewer cleaning equipment every 4 years
- + Retrofitting of existing systems

# Functional principle of SediSubstrator® L –

## Start shaft

as mud collector

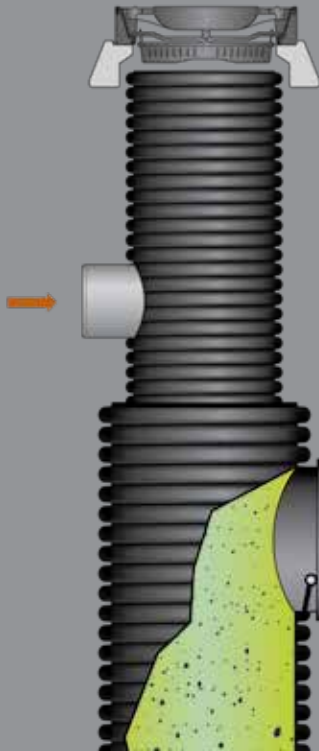

## Sedimentation path

with flow separator

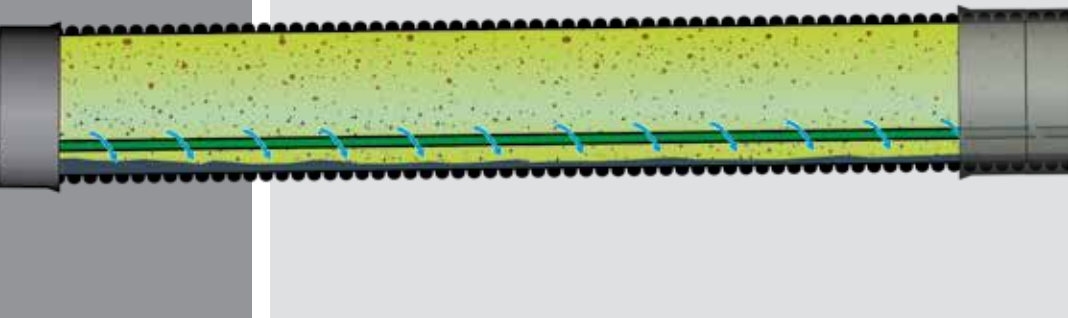

## Retention of coarse particles



Coarse dirt particles settle already in the start shaft. The start shaft acts as a mud collector.

## Optimised sedimentation process of fine particles



The stretched and narrow sedimentation chamber reduces the time and distance until particles settle, and causes flow harmonisation. Both factors together prevent turbulences and thus ensure an optimal sedimentation process.

## Sediment control

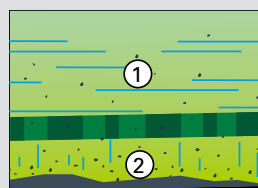

① harmonised plug flow  
② controlled sediment

The patented flow separator technology creates an area with little water movement in the depot, thus preventing remobilisation of the sediment already settled even in case of heavy rains.

# with flow separator technology and substrate filter unit

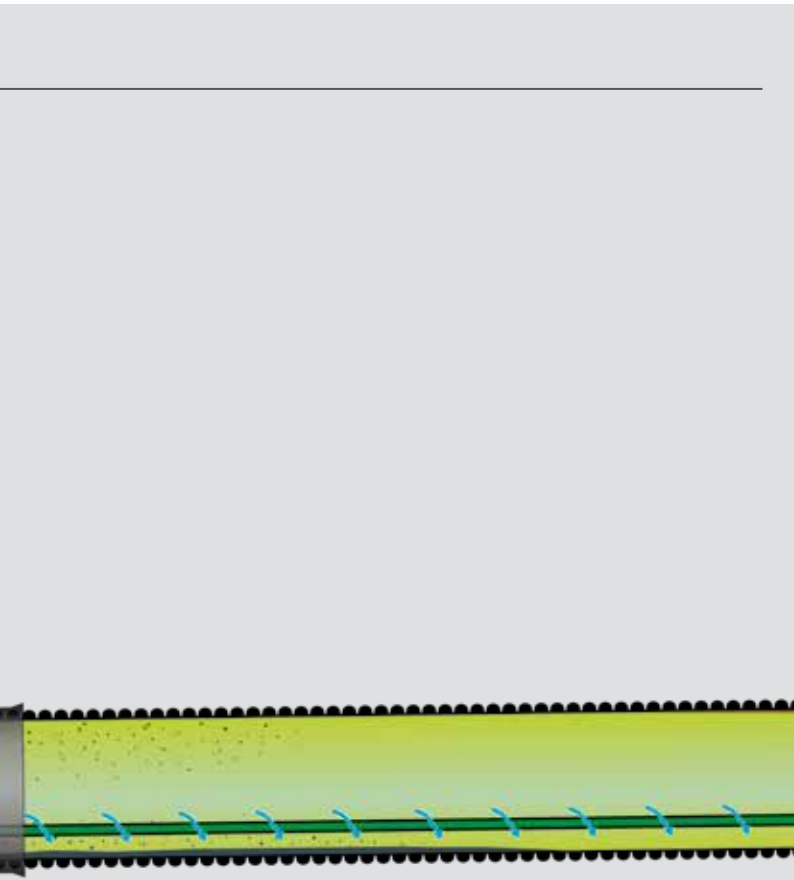

## Target shaft

with immersion wall

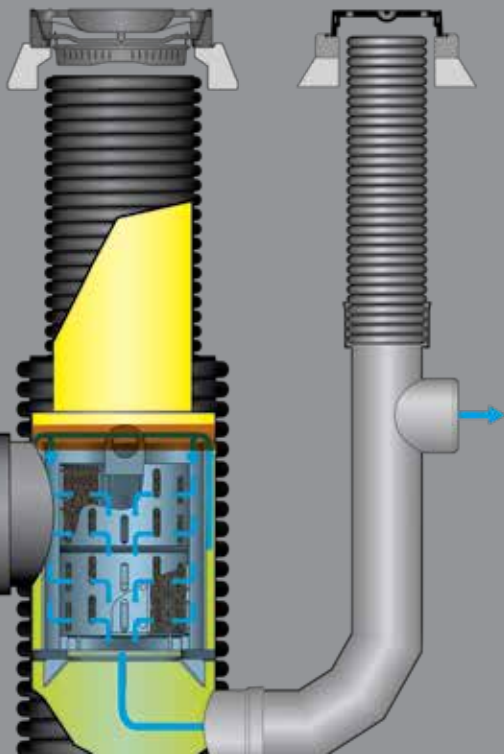

### Retention of light liquids

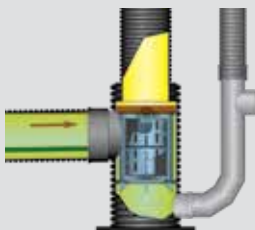

Due to the slight gradient of the pipe, light liquids that rise upwards in the sedimentation path enter the target shaft in which they are collected.

### Highly efficient – the 2-step principle

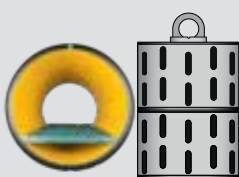

All particles are already retained in the sedimentation path. Only dissolved pollutants arrive in the substrate filter. This excludes the risk of blockages.

### Adsorption of dissolved pollutants and oils

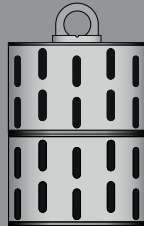

The SediSorp plus used in the substrate filter unit efficiently binds dissolved heavy metals and light liquids.



## The challenges posed by pre-wetted salts

### Problem

Over the year, heavy metals are collected and retained in the adsorption substrate. In order to provide safe roads for pedestrians and drivers also during the winter, winter services use road salts. There are dry salts such as sodium chloride and pre-wetted salts, often with magnesium chloride or calcium chloride. Scientific findings

show that road salts pose the actual danger of remobilising already bound heavy metals in the filter material and thus carrying them into the soil and groundwater.

The DIBt approval procedure already includes a test for resistance to sodium chloride; however, resistance to wet salts with magnesium or calcium chlo-

ride is not considered yet. Handling polluted surface water from traffic areas is a great responsibility. The current situation calls for farsighted solutions, not least regarding upcoming test procedures which will also include resistance to wet salts.

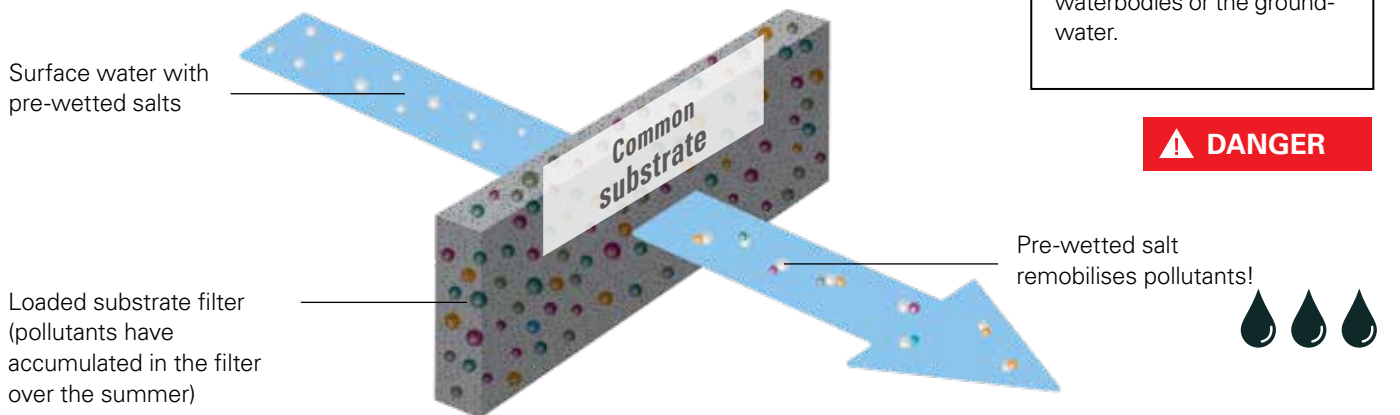



# SediSorp plus



## Pre-wetted salt-resistant adsorption substrate

SediSubstrator L operates with SediSorp plus which has been specifically designed for the growing demands on adsorption substrates. SediSorp plus has been developed based on latest scientific findings in cooperation with the Technical University of Munich. It has been verified to prevent heavy metals

being carried into the soil and groundwater. Treatment systems with SediSorp plus are the first to offer a technology featuring proven resistance to pre-wetted salts. It therefore ensures both long-term road safety and protection of the soil and groundwater.



SediSorp plus has been verified to prevent remobilisation of already bound pollutants.

NOTE



# Maintenance

## Sedimentation system

Common sewer cleaning methods are used to clean the system. All work is performed without requiring access from above ground. The system keeps a permanent water level which ensures that the sediment remains muddy. The contents of

the system are vacuumed from the start shaft. The valve flap opens and releases the sediment to the lowest point. The system is flushed afterwards.



Maintenance interval

### Step 1: Emptying with vacuum hose

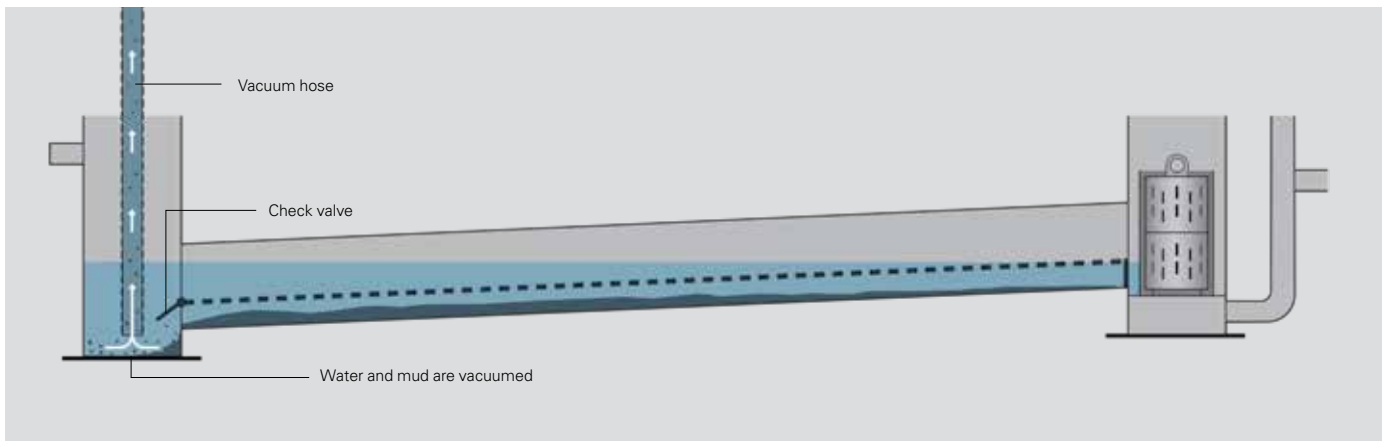

### Step 2: Cleaning with vacuum and flush hose

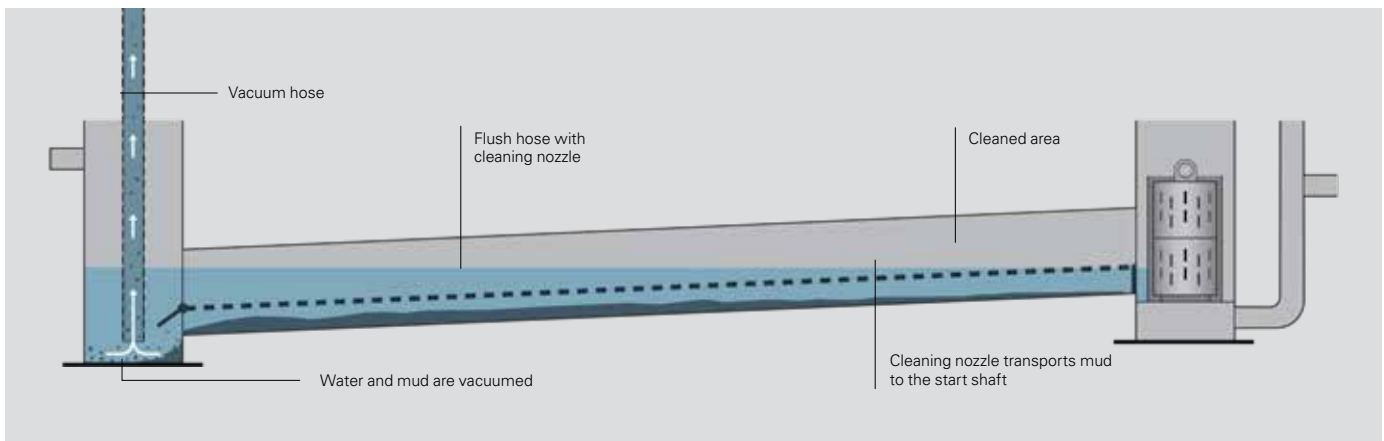

# Maintenance



## Substrate filter unit

### Note

Please refer to the installation and maintenance manual for a detailed description.

 [www.fraenkische.com](http://www.fraenkische.com)



Maintenance interval

- 1 Remove the cartridge elements from the shaft and clean the target shaft for maintenance.



- 2 Exchange the filter substrate (SediSorp plus).

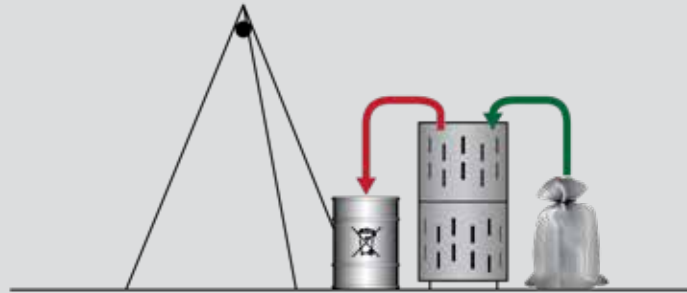

- 3 Return the refilled substrate cartridge – done!

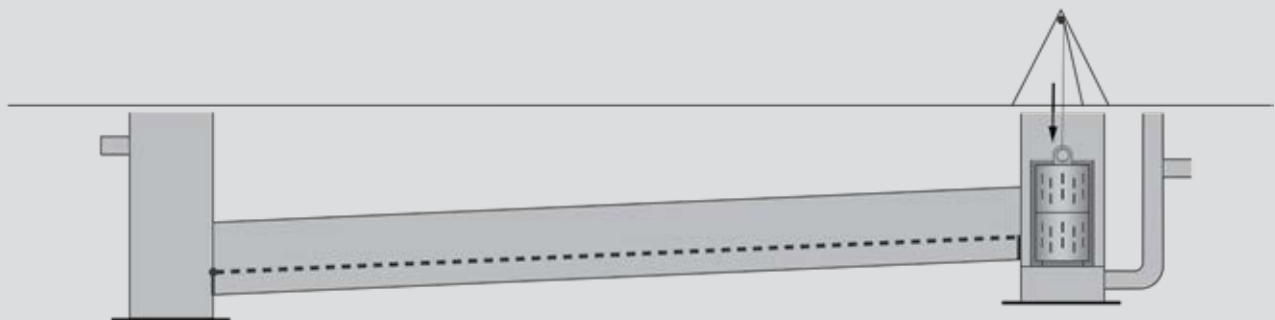

## Performance parameters – SediSubstrator® L

SediSubstrator L can be perfectly tailored to specific project needs. The system size is simply selected according to the area to be connected. The 600/12+12 system can be used for two separate connectable areas.

The DIBt test principles do not require that an emergency overflow is included in the system (full flow treatment). A project-specific installation outside of

the system, e.g., in separate receiving waters, must be agreed with the approving authority, if necessary. Network-hydraulic relations must thus be analysed for each specific project. Project-specific hydraulic proof can be provided upon request.

# D 11

Recommended pass-through value  
acc. to DWA bulletin M 153  
for DIBt-approved systems

## 0.15

### System overview – SediSubstrator L

Type	Connectable area (m <sup>2</sup> )	Sedimentation path		Number of cartridge elements
		DN	Length (m)	
600/6	750	600	6	1
600/12	1,500	600	12	2
600/18	2,250	600	18	3
600/24	3,000	600	24	4
600/12+12	1,500+1,500	600	12+12	4





# Connection geometries – SediSubstrator® L

## Connection angles

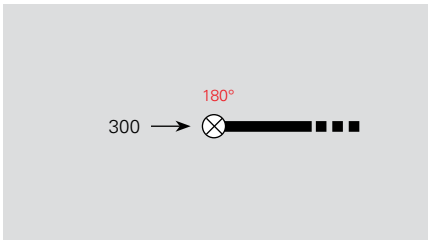

Plan start shaft, inlet (DN300)

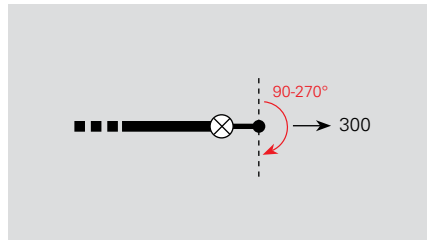

Plan target shaft, outlet (DN 300)

## Arrangement of multiple systems

The following describes the recommendations for the arrangement of multiple systems and the required minimum distances. We draw your attention to the fact that for installation clearances

between distribution and combining units and the treatment system, the respective fitting dimensions of the connection pipes and their space requirements must be considered for the installation in

addition to the general minimum clearances specified by standards.

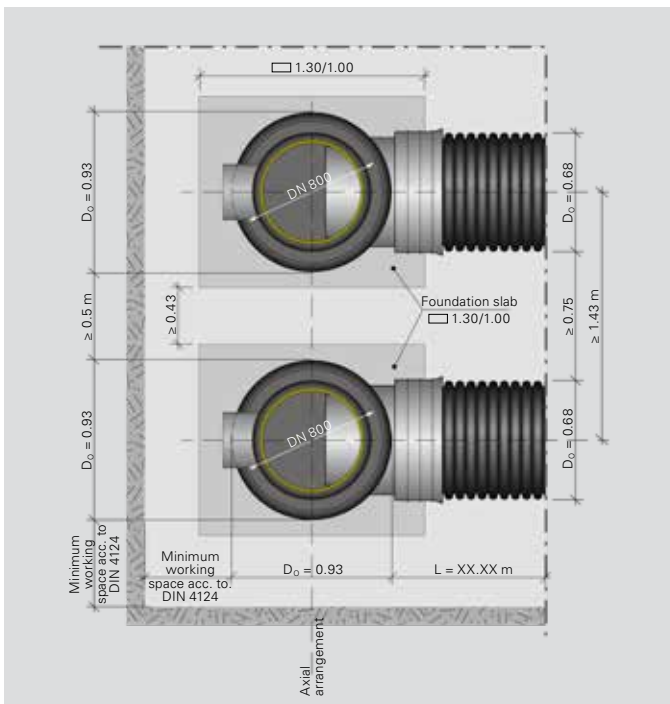

Axial arrangement

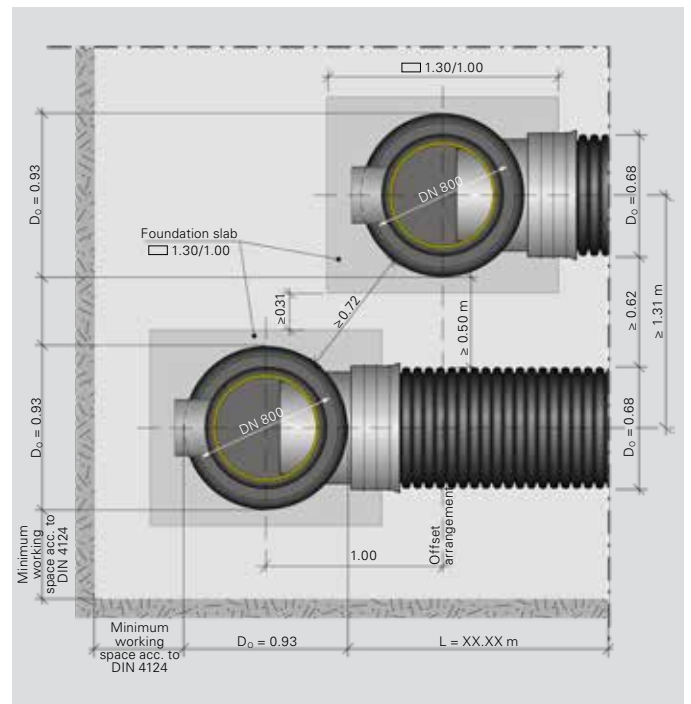

Offset arrangement

We recommend a minimum clearance of 1.43 m or more referring to the shaft centres for axial arrangements. We recommend a minimum spacing between the axes of 1.31 m for offset arrangements of shaft constructions. Additionally, pay

attention to the offset arrangement of shaft constructions of 1.0 m or more. If the recommended clearances for the respective installation situations are complied with, there is a breadth of working space of at least 0.5 m between the two

shaft constructions or between the shaft construction and the sedimentation path. This is to ensure professional compaction between the system components using light compacting equipment.

# Technical data – SediSubstrator® L

Systems of the SediSubstrator L type can be used universally for a wide range of purposes:

- Installation upstream of or parallel to an infiltration swale
- Arrangement upstream of the discharge into a surface waterbody or sewer

The systems feature a bottom step of 25 cm between inlet and outlet. The inlet DN/OD 315 leads straight into the system (180°). The outlet DN/OD 315 can be freely rotated on site between straight (180°), left (90°) and right (270°). The system can therefore easily be adapted to on-site requirements.

The stability of the system has been proven by standard statics. For soil temperatures up to 23 °C, maximum installa-

tion depths of the shafts up to 6 m, also in case of groundwater, are possible depending on installation parameters.

The minimum depth of the system derives from the minimum required distance between the pipe crown, inlet and/or outlet channel and the bottom edge of the BARD ring of 35 cm. When using a conventional class D cover without equalisation ring, this corresponds to an inlet channel soil depth of 1.02 m.

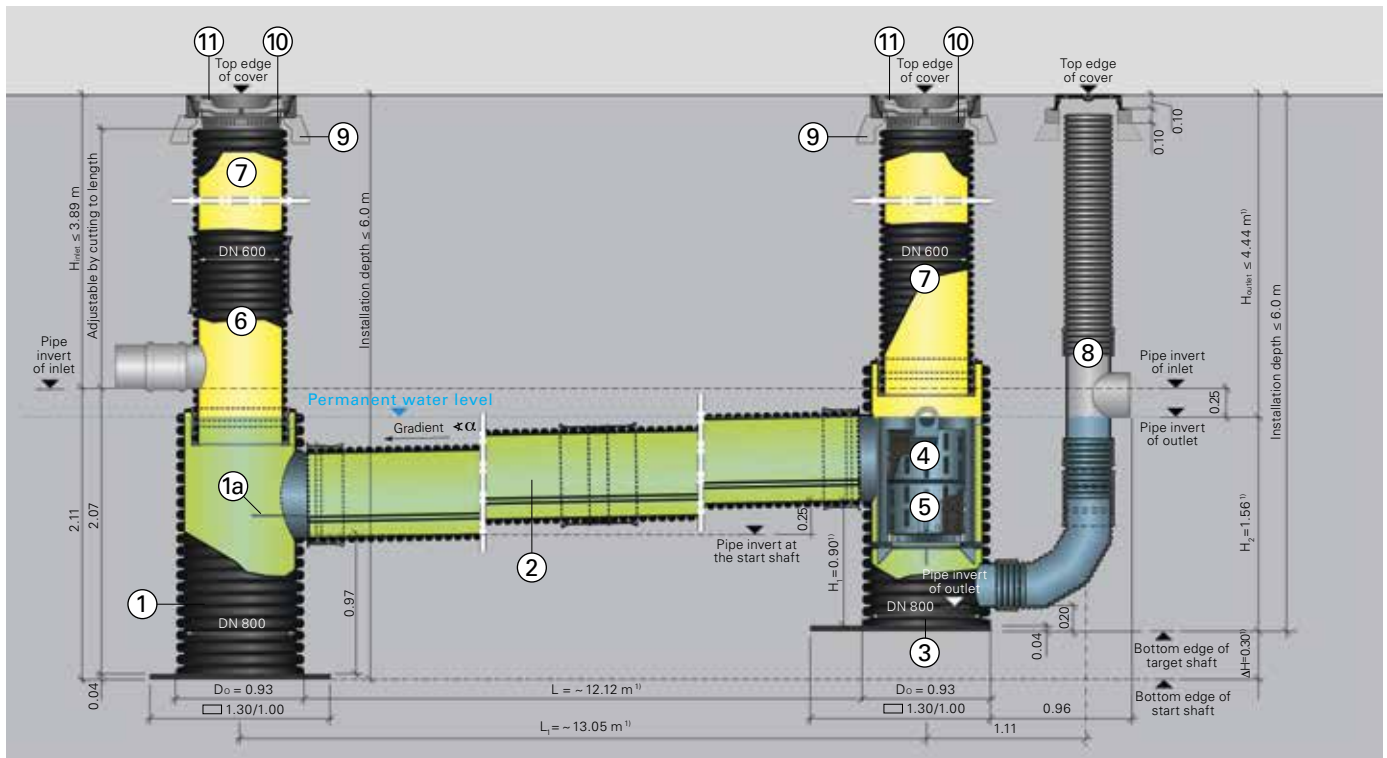

Example: SediSubstrator L 600/12

<sup>1)</sup> with SediSubstrator L 600/12

SediSubstrator L	600/6	600/12	600/18	600/24	600/12+12
Length "L" [m]	6.10	12.12	18.17	24.22	12.12 + 12.12
Length "L <sub>1</sub> " [m]	7.03	13.05	19.10	25.15	13.05 + 13.05
Height "H1" [m]	0.90	0.90	1.27	1.61	1.61
Height "H2" [m]	1.56	1.56	1.86	2.26	2.26
Height "ΔH" [m]	0.30 <sup>1)</sup>	0.30 <sup>1)</sup>	0.05 <sup>2)</sup>	0.39 <sup>2)</sup>	0.39 <sup>2)</sup>
H <sub>outlet</sub>	≤ 4.44	≤ 4.44	≤ 4.14	≤ 3.74	≤ 3.74
Diameter of the sedimentation path [mm]	600	600	600	600	600
Length of the sedimentation path [m]	6	12	18	24	12 + 12
Sedimentation path gradient [%]	4.0	2.0	1.3	1.0	2.0
Sedimentation path gradient as angle [α]	2.3°	1.1°	0.8°	0.6°	1.1°
Number of cartridge elements	1	2	3	4	4
■ of which cover element	1	1	1	1	1
■ of which base element	0	1	2	3	3
Collecting volume of light liquids <sup>3)</sup> [litres]	2100	3390	4840	6290	6650
Collecting volume of the mud chamber [litres]	770	970	1180	1390	1950

<sup>1)</sup> Bottom edge of start shaft is lower than bottom edge of target shaft;

<sup>2)</sup> Bottom edge of start shaft is higher than bottom edge of target shaft

<sup>3)</sup> Retention of light liquids in case of spills

# Technical data – SediSubstrator® L

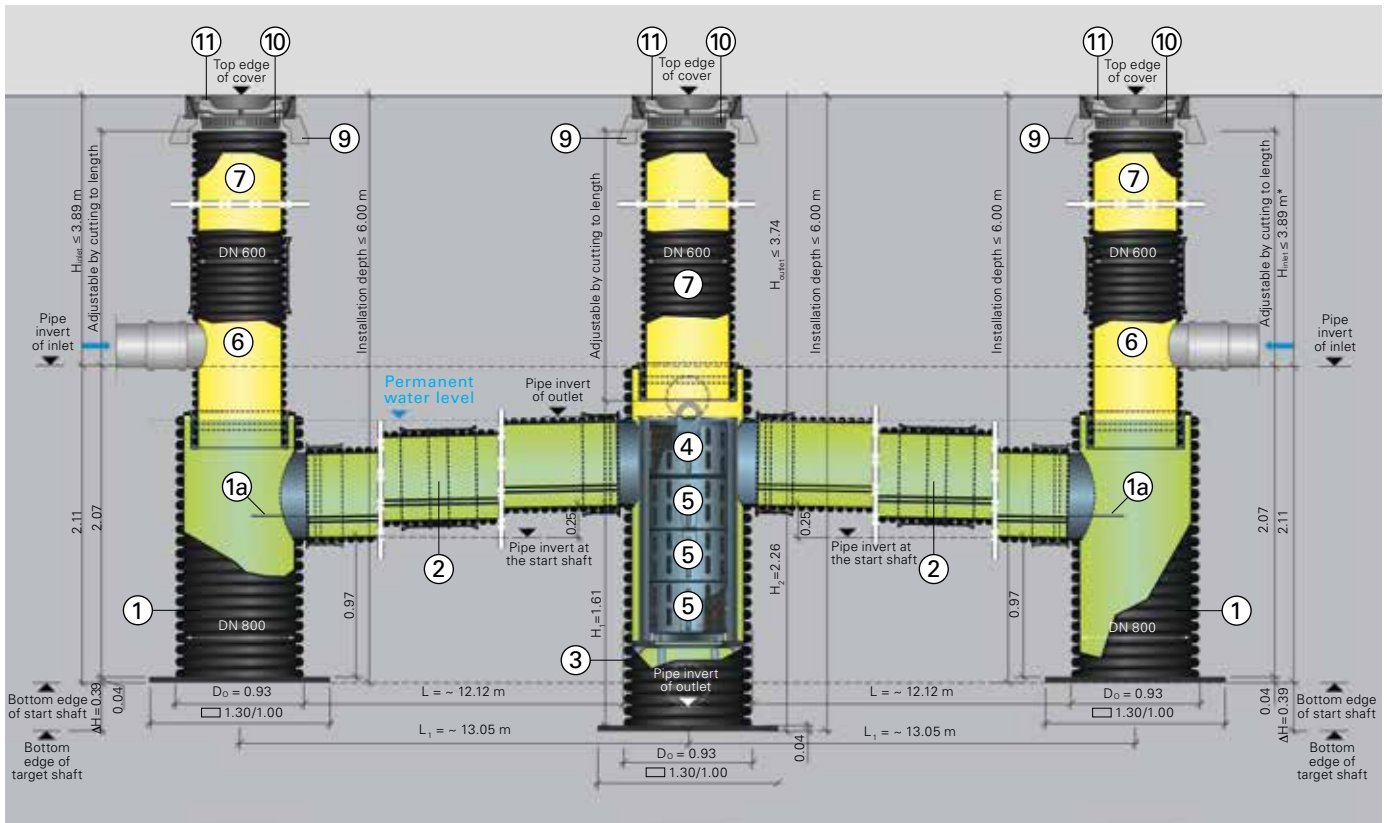

Example: SediSubstrator L 600/12+12

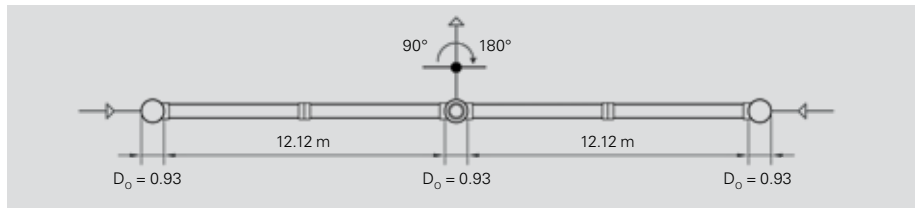

SediSubstrator L 600/12+12

## Legend

- ① Start shaft bottom with
- ①a maintenance console
- ② Sedimentation path with flow separator
- ③ Target shaft bottom
- ④ Substrate cartridge cover element
- ⑤ Substrate cartridge base element
- ⑥ Inlet set DN 600
- ⑦ Extension pipe DN/ID 600
- ⑧ Outlet incl. class D 400 cover
- ⑨ BARD ring (class D concrete support ring)
- ⑩ Dirt trap acc. to DIN 1221<sup>1)</sup>
- ⑪ Shaft cover CW 610<sup>1)</sup>

<sup>1)</sup> to be supplied on site

## Shaft cover CW 610 (on site) and BARD ring

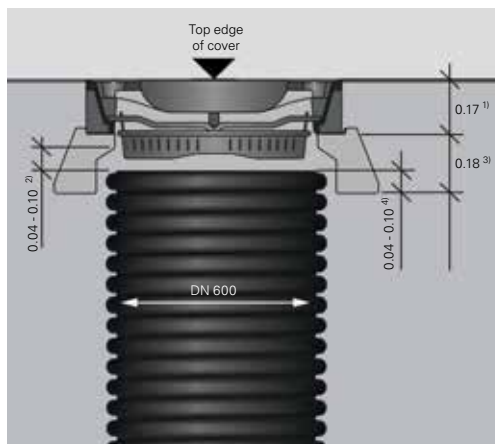

- <sup>1)</sup> Height of shaft cover incl. 1 cm mortar joint. The dimension is variable, depending on class B or D shaft cover and use of additional support rings (incl. mortar joint to ensure a bearing without stationary loads).
- <sup>2)</sup> Compensating area: 4 cm to 10 cm
- <sup>3)</sup> BARD ring, inside Ø 745 mm, h=180 mm
- <sup>4)</sup> Insertion area: Extension pipe in BARD ring 4 cm to 10 cm, height adjustment in the insertion area accurate to within the last centimetre possible.

## Ordering data – SediPipe® L / SediPipe® L plus

### Note

The system is comprised of a SediPipe L / L plus basic set and, depending on the sewer depth, a connection set and the covers to be supplied on site.

### SediPipe L basic set



#### SediPipe L components:

- Start shaft bottom DN 800
- Target shaft bottom DN 800
- Sedimentation path with lower flow separator DN 600  
incl. possibly required couplings and sealing rings
- Profile sealing rings DN 600

Product	Technical data	Cat. no.
SediPipe L 600/6 basic set	Sedimentation path DN 600, 6 m length (1x6 m)	<b>515.97.806</b>
SediPipe L 600/12 basic set	Sedimentation path DN 600, 12 m length (2x6 m)	<b>515.97.812</b>
SediPipe L 600/18 basic set	Sedimentation path DN 600, 18 m length (3x6 m)	<b>515.97.818</b>
SediPipe L 600/24 basic set	Sedimentation path DN 600, 24 m length (4x6 m)	<b>515.97.824</b>

### SediPipe L plus basic set

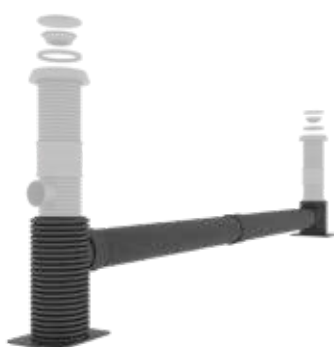

#### SediPipe L plus components:

- Start shaft bottom DN 800
- Target shaft bottom DN 800
- Sedimentation path with lower and upper flow separator DN 600  
incl. possibly required couplings and sealing rings
- Profile sealing rings DN 600

Product	Technical data	Cat. no.
SediPipe L plus 600/6 basic set	Sedimentation path DN 600, 6 m length (1x6 m)	<b>515.97.906</b>
SediPipe L plus 600/12 basic set	Sedimentation path DN 600, 12 m length (2x6 m)	<b>515.97.912</b>
SediPipe L plus 600/18 basic set	Sedimentation path DN 600, 18 m length (3x6 m)	<b>515.97.918</b>
SediPipe L plus 600/24 basic set	Sedimentation path DN 600, 24 m length (4x6 m)	<b>515.97.924</b>

## Ordering data – SediPipe® L / SediPipe® L plus



### SediPipe L | SediPipe L plus connection set for sewer depths up to 2.5 m

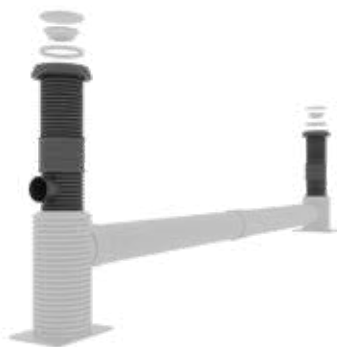

Product	Technical data	Cat. no.
Connection set SediPipe DN 315 for sewer depth up to 2.50 m	inlet set DN 600 with connection DN/OD 315; outlet set DN 600 with connection DN/OD 315; 2 x extension pipes DN 600, 1.6 m length; incl. couplings and sealing rings; 2 x class D BARD rings	<b>515.97.850</b>
Connection set SediPipe DN 400 for sewer depth up to 2.50 m	inlet set DN 600 with connection DN/OD 400; outlet set DN 600 with connection DN/OD 400; 2 x extension pipes DN 600, 1.6 m length; incl. couplings and sealing rings; 2 x class D BARD rings	<b>515.97.860</b>
SediPipe connection set including additional connection Inlet: 1 x DN400, 2 x DN315; Outlet: 1 x DN400 for sewer depth up to 2.50 m	inlet set DN 600 with connections DN/OD 400, DN/OD 315 and DN/OD 315; outlet set DN 600 with connection DN/OD 400; 2 x extension pipe DN 600, 1.6 m length; incl. couplings and sealing rings; 2 x class D BARD ring	<b>515.97.855</b>

### SediPipe L | SediPipe L plus connection set for sewer depths greater than 2.5 m

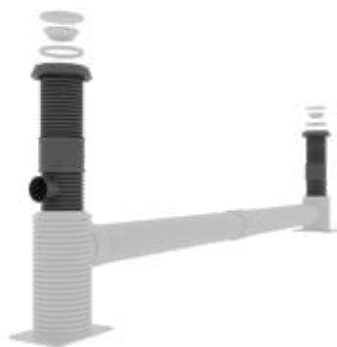

Product	Technical data	Cat. no.
Connection set SediPipe DN 315 for sewer depths greater than 2.50 m	inlet set DN 600 with connection DN/OD 315; outlet set DN 600 with connection DN/OD 315; extension pipe DN 600, 2.9 m length; extension pipe DN 600, 3.8 m length; incl. couplings and sealing rings; 2 x class D BARD rings	<b>515.97.851</b>
Connection set SediPipe DN 400 for sewer depths greater than 2.50 m	inlet set DN 600 with connection DN/OD 400; outlet set DN 600 with connection DN/OD 400; extension pipe DN 600, 2.9 m length; extension pipe DN 600, 3.8 m length; incl. couplings and sealing rings; 2 x class D BARD rings	<b>515.97.861</b>
SediPipe connection set including additional connection Inlet: 1 x DN 400, 2 x DN 315; Outlet: 1 x DN 400 for sewer depths greater than 2.50 m	inlet set DN 600 with connections DN/OD 400, DN/OD 315 and DN/OD 315; outlet set DN 600 with connection DN/OD 400; extension pipe DN 600, 2.9 m length; extension pipe DN 600, 3.8 m length; incl. couplings and sealing rings; 2 x class D BARD rings	<b>515.97.856</b>

### To be ordered / supplied on site



Product	Technical data	Cat. no.
Covers CW 610	with ventilation	<b>To be ordered / supplied on site</b>
Dirt trap		
Support rings	(optional)	

## Ordering data – SediSubstrator® L

### Note

The system is comprised of a SediSubstrator L basic set and a connection set and the covers to be supplied on site.

### SediSubstrator L basic set



#### SediSubstrator L components:

- Start shaft bottom DN 800
- Target shaft bottom DN 800
- Sedimentation path DN 600 with lower flow separator incl. possibly required couplings and sealing rings
- Substrate cartridge(s)
- Outlet bend DN 300 with intermediate pipe DN 300 incl. sealing rings

Product	Technical data	Cat. no.
Basic set SediSubstrator L 600/6	6 m length of sedimentation path (1x6 m) 1 substrate cartridge cover element	<b>515.98.891</b>
Basic set SediSubstrator L 600/12	12 m length of sedimentation path (2x6 m) 1 substrate cartridge cover element 1 substrate cartridge base element	<b>515.98.892</b>
Basic set SediSubstrator L 600/18	18 m length of sedimentation path (3x6 m) 1 substrate cartridge cover element 2 substrate cartridges base element	<b>515.98.893</b>
Basic set SediSubstrator L 600/24	24 m length of sedimentation path (4x6 m) 1 substrate cartridge cover element 3 substrate cartridges base element	<b>515.98.894</b>
Basic set SediSubstrator L 600/12+12	2x12 m length of sedimentation path (2x6 m) additional start shaft bottom DN 800 1 substrate cartridge cover element 3 substrate cartridges base element	<b>515.98.896</b>

## Ordering data – SediSubstrator® L



### SediSubstrator L connection set for 600/6, 600/12, 600/18, 600/24

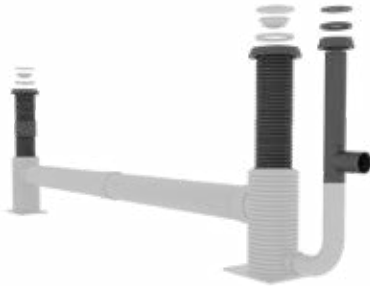

Product	Technical data	Cat. no.
Connection set SediSubstrator L DN 315 for sewer depth up to 2.50 m	inlet set DN 600 with connection DN/OD 315; extension pipe DN 600, 1.6 m length; extension pipe DN 600, 2.2 m length; incl. couplings and sealing rings; 2 x class D BARD rings; outlet tee DN 300 to DN/OD 315; extension pipe DN 300, 2.15 m length, incl. sealing rings; shaft cover CW 410, class D 400 without ventilation openings, incl. concrete support ring	<b>515.98.850</b>
Connection set SediSubstrator L DN 315 for sewer depths greater than 2.50 m	inlet set DN 600 with connection DN/OD 315; extension pipe DN 600, 2.9 m length; extension pipe DN 600, 4.1 m length; incl. couplings and sealing rings; 2 x class D BARD rings; outlet tee DN 300 to DN/OD 315; extension pipe DN 300, 4.15 m length, incl. sealing rings; shaft cover CW 410, class D 400 without ventilation openings, incl. concrete support ring	<b>515.98.851</b>

### SediSubstrator L connection set for 600/12+12

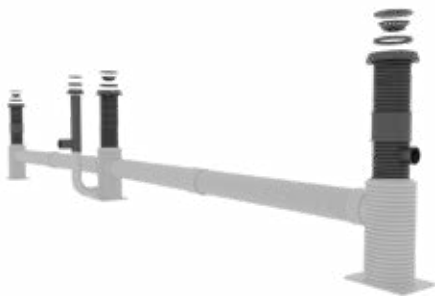

Product	Technical data	Cat. no.
Connection set SediSubstrator L 600/12+12 DN 315 for sewer depths up to 2.50 m	2 x inlet sets DN 600 with connection DN/OD 315; 2 x extension pipes DN 600, 1.6 m length; extension pipe DN 600, 2.2 m length; incl. couplings and sealing rings; 3 x class D BARD rings; outlet tee DN 300 to DN/OD 315; extension pipe DN 300, 2.15 m length, incl. sealing rings; shaft cover CW 410, class D 400 without ventilation openings, incl. concrete support ring	<b>515.98.855</b>
Connection set SediSubstrator L 600/12+12 DN 315 for sewer depths greater than 2.50 m	2 x inlet sets DN 600 with connection DN/OD 315; 2 x extension pipes DN 600, 2.9 m length; extension pipe DN 600, 4.1 m length; incl. couplings and sealing rings; 3 x class D BARD ring; outlet tee DN 300 to DN/OD 315; extension pipe DN 300, 4.15 m length, incl. sealing rings; shaft cover CW 410, class D 400 without ventilation openings, incl. concrete support ring	<b>515.98.856</b>

### To be ordered / supplied on site



Product	Technical data	Cat. no.
Covers CW 610	with ventilation	<b>To be ordered / supplied on site</b>
Dirt trap		
Support rings	(optional)	

# Contact

## International Sales Director

Horst Dörr +49 9525 88-2490  
horst.doerr@fraenkische.de

## International Sales

Dinah Nigrowics +49 9525 88-8155  
dinah.nigrowics@fraenkische.de

## Technology

Stefan Weiß +49 9525 88-8824  
stefan.weiss@fraenkische.de

Andreas Lang +49 9525 88-8216  
andreas.lang@fraenkische.de

## European Sales Director

Klaus Lichtscheidel +49 9525 88-8066  
klaus.lichtscheidel@fraenkische.de

## European Sales

Jennifer Gernert +49 9525 88-2569  
jennifer.gernert@fraenkische.de

Carolin Rausch +49 9525 88-2229  
carolin.rausch@fraenkische.de

Viktoria Majewski +49 9525 88-2103  
viktoria.majewski@fraenkische.de

**Fax +49 9525 88-2522**







## 4 challenges – 1 solution:

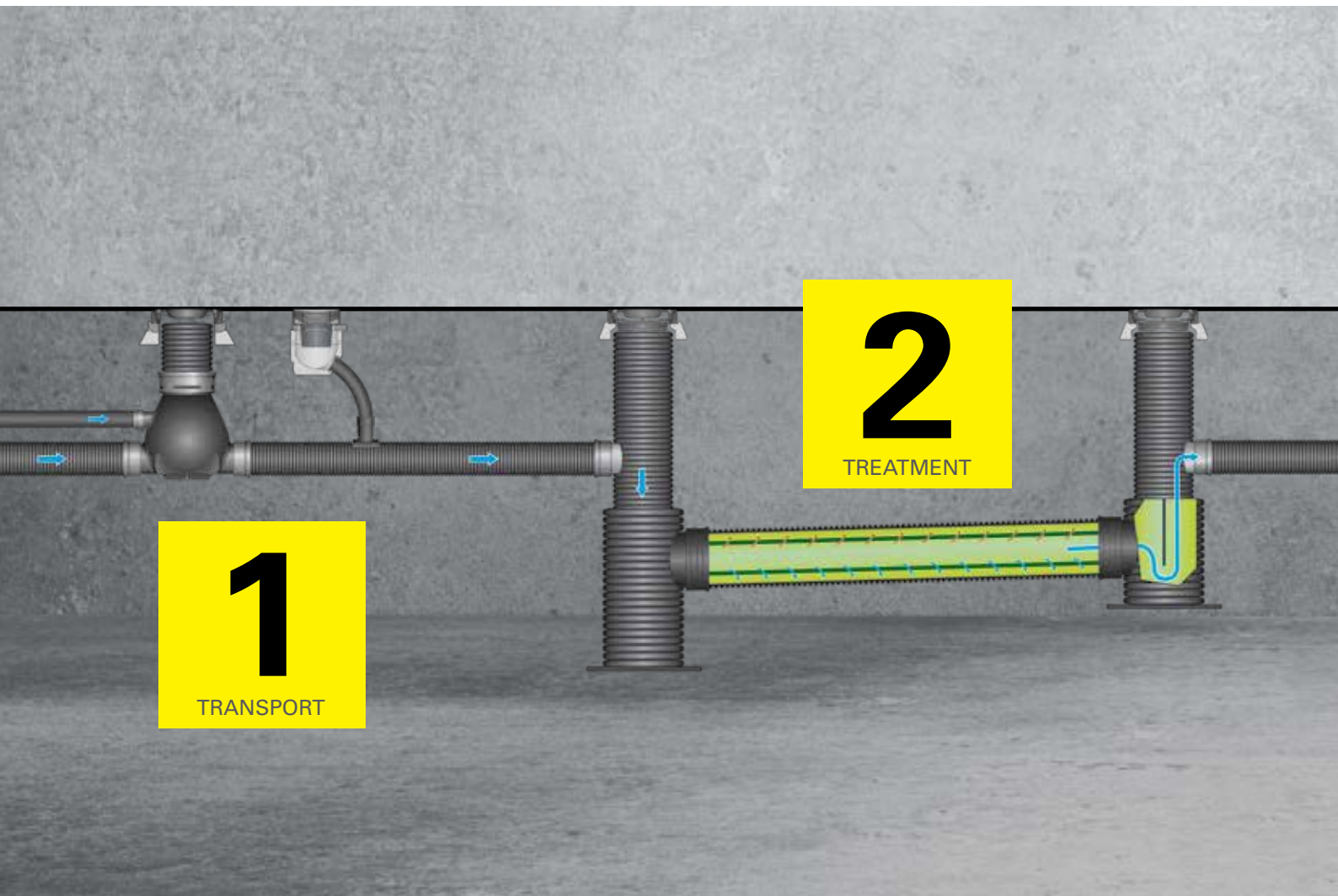

## Stormwater is our competence.

Rain falls on roads, squares, roofs, airports, stadiums and many other paved surfaces. Wherever it cannot be treated, stored and discharged naturally, our competencies are needed: **re-establishing the natural water cycle where it has been interrupted and re-channelling water back to natural storage areas – economically, ecologically and wisely.**

We have been working in the fields of **stormwater management, urban drainage, as well as road and track drainage** for more than 30 years. We know today that every task related to stormwater requires integrated, systems thinking.

Our solutions are characterised by:

- 100 % physical, functional and systematic reliability of all components,
- 100 % compatibility of all components and systems in the functional chain,
- Long durability and excellent maintenance-friendliness across all areas of operation.

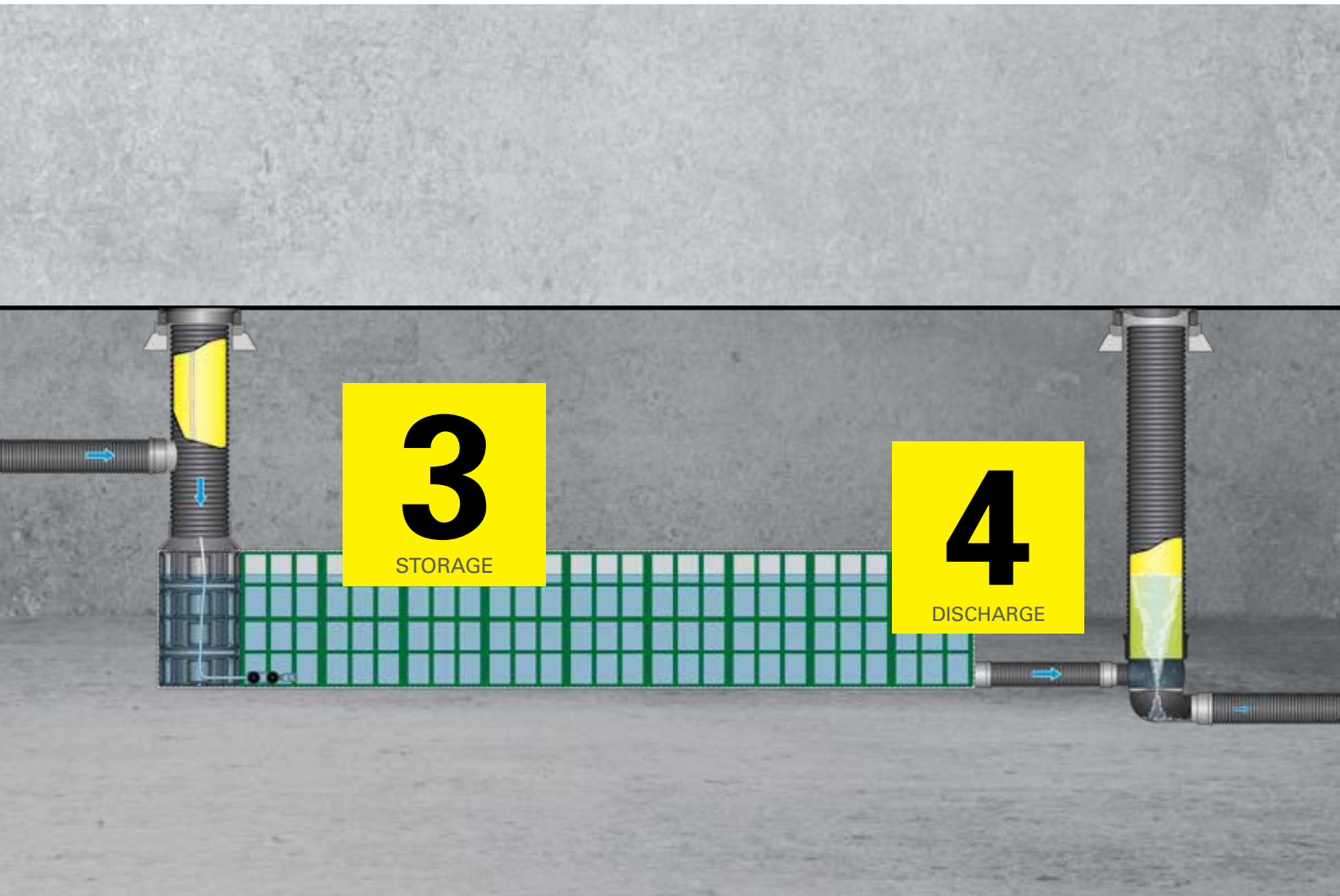

We provide full service, i.e., all system components including all steps before or after construction can be provided from a single source, if necessary.

On the one hand, this makes project realisation highly efficient and, on the other hand, guarantees efficient system maintenance. In this context, we focus on protecting our customers' investments.

All our drainage systems always meet the four fundamental tasks in handling stormwater:

- Transport
- Treatment
- Storage
- Discharge

Depending on the project-specific framework conditions, we combine our well-matched product components to create a complete system, thus providing an integrated system solution to your drainage needs. Our focus is on meeting all requirements under public law in accordance with the needs of the operators. Finally, the natural water cycle is re-established.

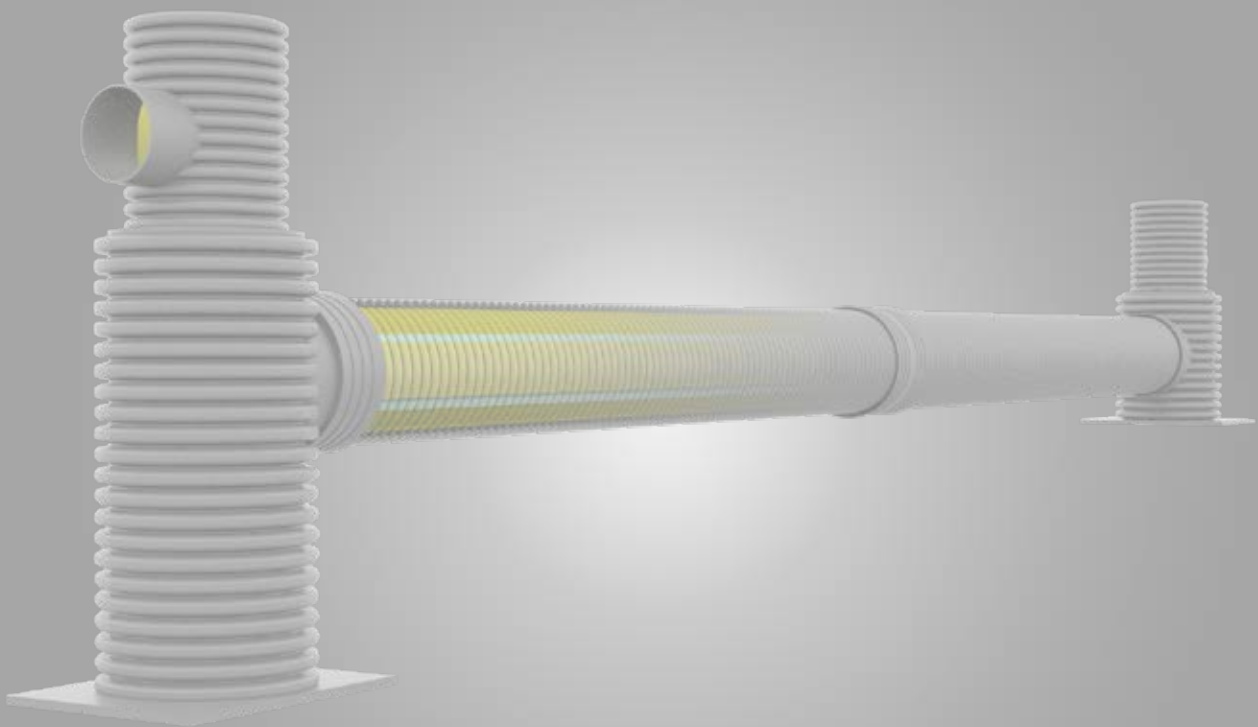

© www.adbestock.de

# FRÄNKISCHE

FRÄNKISCHE Rohrwerke Gebr. Kirchner GmbH & Co. KG | Hellinger Str. 1 | 97486 Königsberg/Germany  
Phone +49 9525 88-2200 | Fax +49 9525 88-92200 | [marketing@fraenkische.de](mailto:marketing@fraenkische.de) | [www.fraenkische.com](http://www.fraenkische.com)

DE.1437/2.06.19 | Subject to change without notice | Cat. no. 59913199 | 06/2019

